

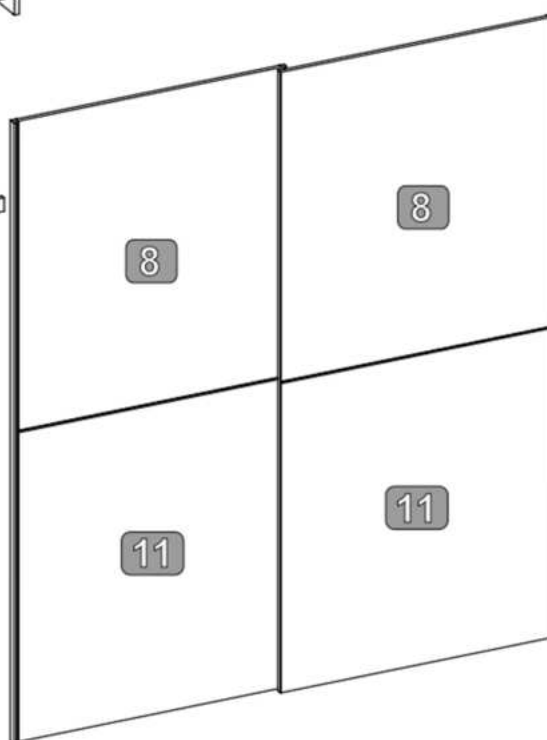





















KÓD BROJ KODA COD	ROZMER ROZMÉR DIMENZIJA DIMENZIJE DIMENSIUNE		BALÍK BALÍČEK CSOMAG PAKET PACHET
1	1670x519x15	1	1/2
2	1902x847x2	2	1/2
3	1670x42x15	1	1/2
4	1670x42x15	1	1/2
5	1950x520x15	1	1/2
6	1670x504x15	1	1/2
7	1950x549x15	1	1/2
8	865x962,5x15	2	2/2
9	827,5x420x15	2	2/2
10	1877x421x15	1	2/2
11	865x962,5x15	2	2/2

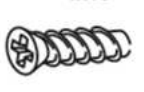

 15x12 20x T02	 20x T01	 8x28 20x D01	 7x50 4x W51	 Z4 1x K01	 5x40 8x W16
 L3 1x K02	 Ø13 8x C01b	 6x S01	 4x E03	 9x BZN	 4x W08
 4x13 11x W07	 3,5x25 4x W36	 H-29 2x Za3	 3x KL2	 4x13 24x W13	 3,5x13 65x W02
 3 x13 8x W03	 75x G01	 2x F13	 2x F01	 2x F11	 L-823 2x J01

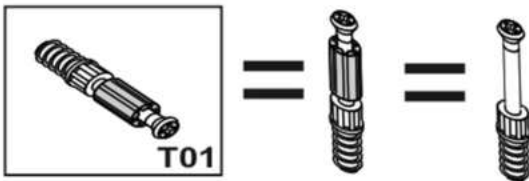

0 10 20 30 40 50 60 70 80 90 100



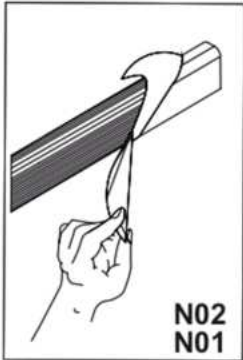
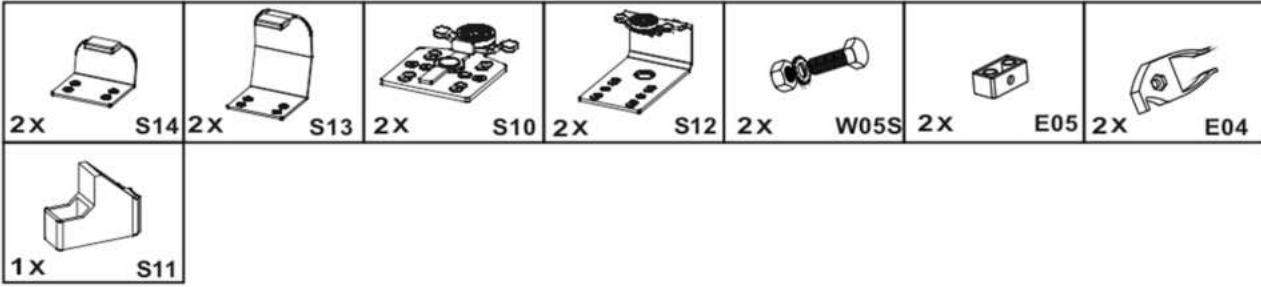

KÓD BROJ KODA COD	ROZMER ROZMĚR DIMENZIÓ DIMENZIJA DIMENSIJE DIMENSIUNE		BALÍK BALÍČEK CSOMAG PAKET PACHET
N02	L-1925 H-29	2	2/2
N01	L-1925	2	2/2
S15	L-1668	1	1/1
S16	L-1668	1	1/1

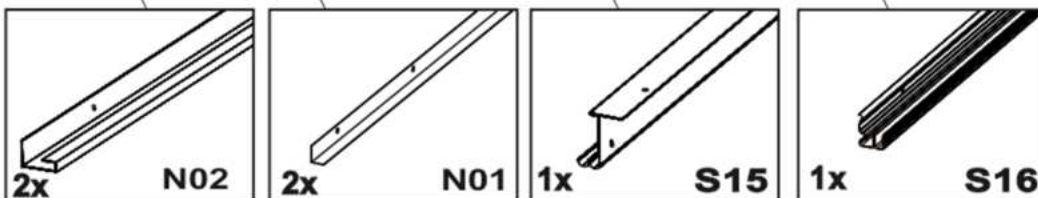
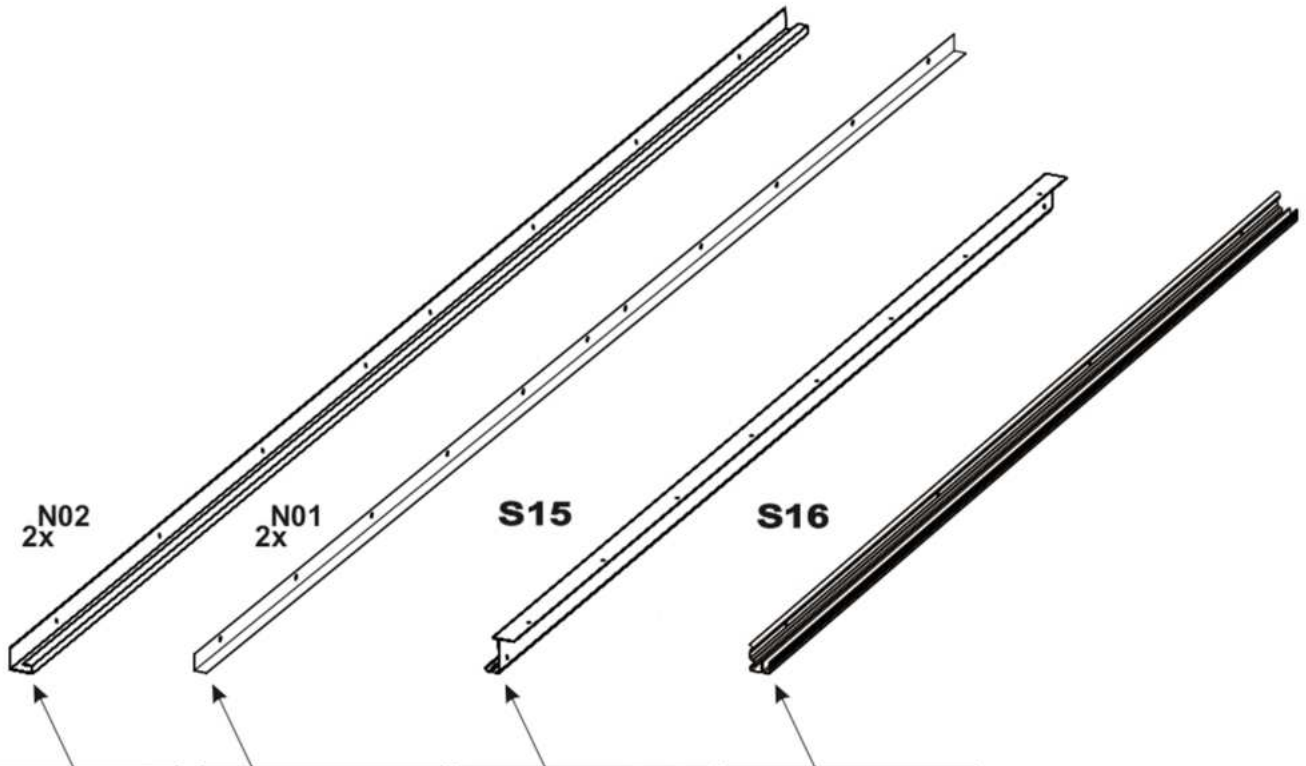

1

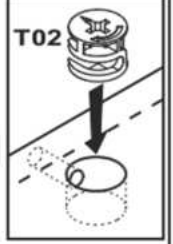
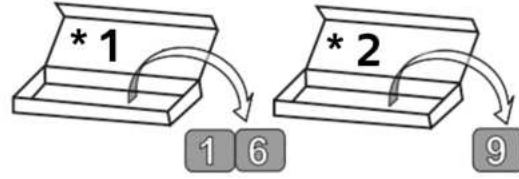
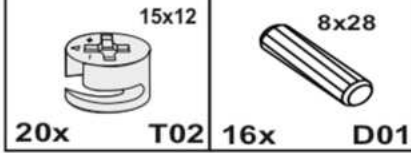

* BALÍK
BALÍČEK
CSOMAG
PAKET
PACHET

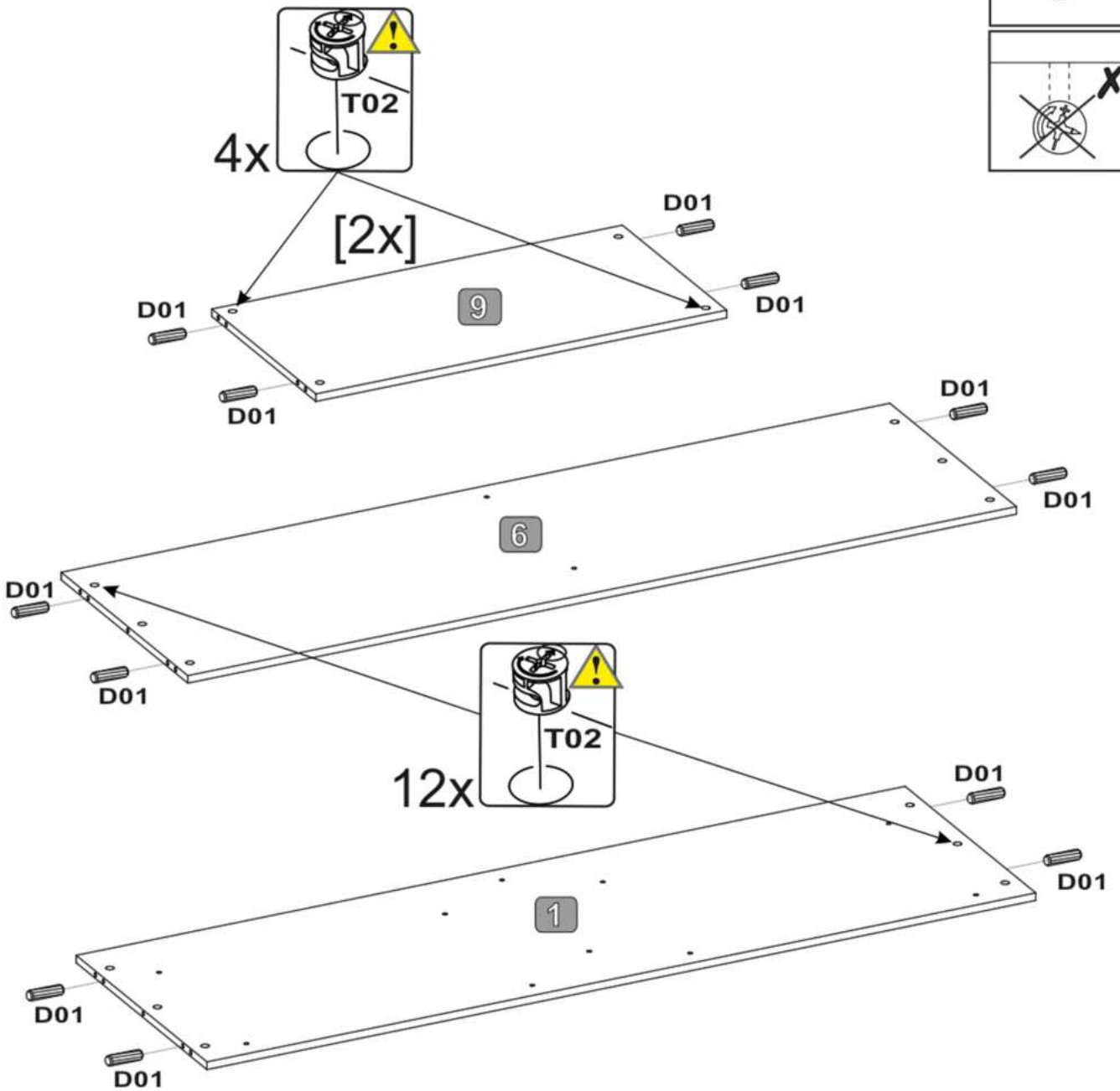

2

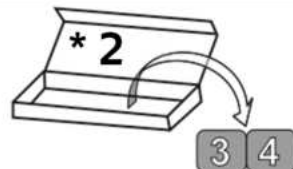
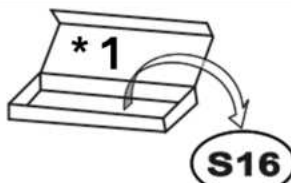
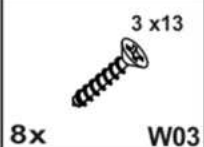
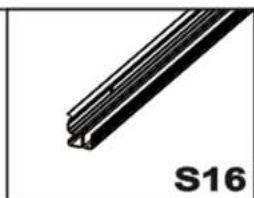



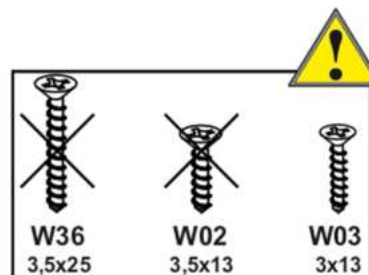
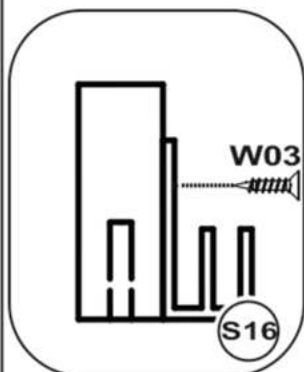
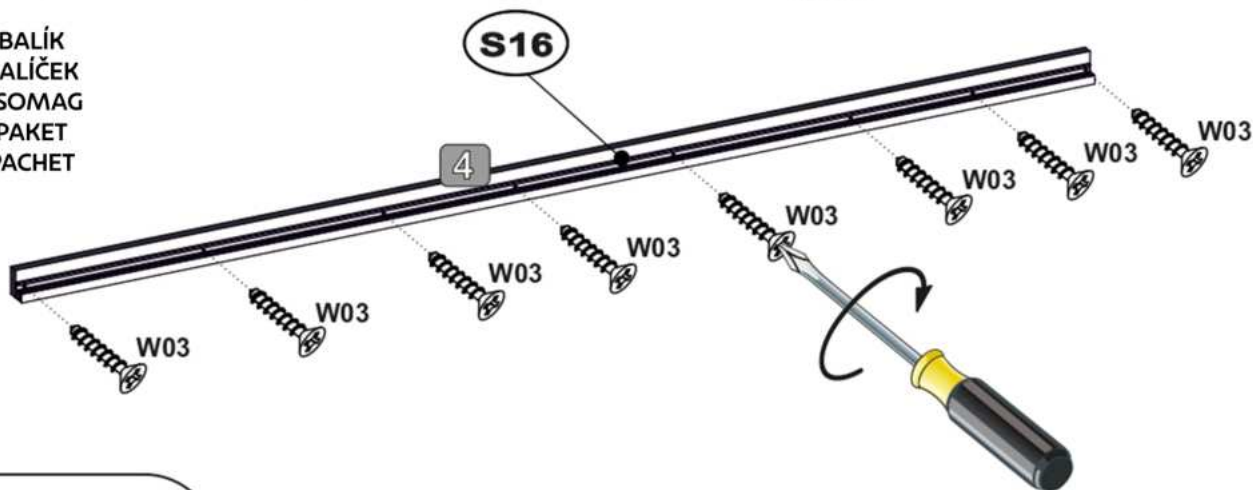

* BALÍK
BALÍČEK
CSOMAG
PAKET
PACHET

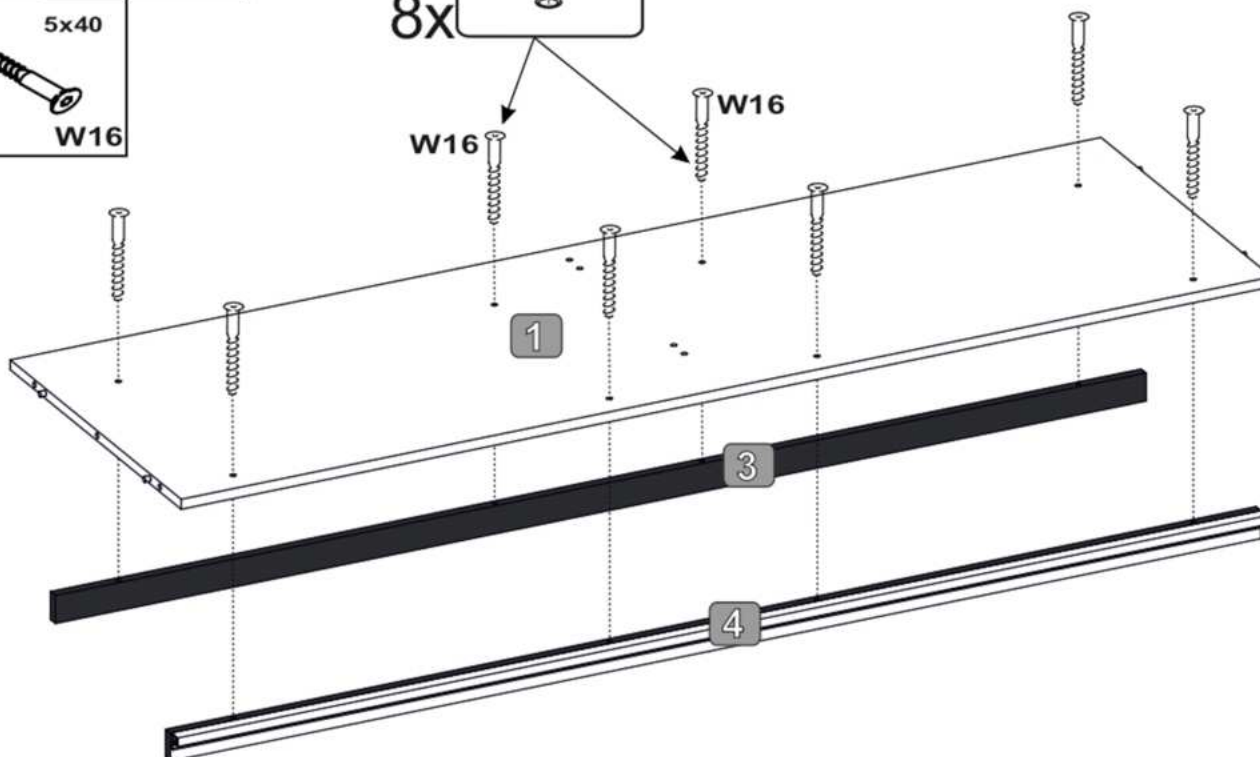
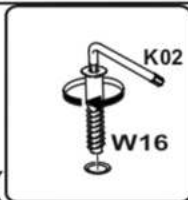
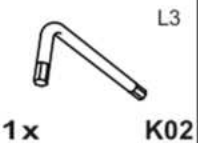

3



4

 16x T01	 4x S01	 2x E03	 3,5x13 4x W02
--	---	---	---

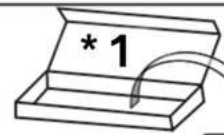



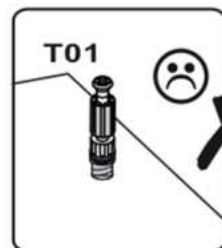
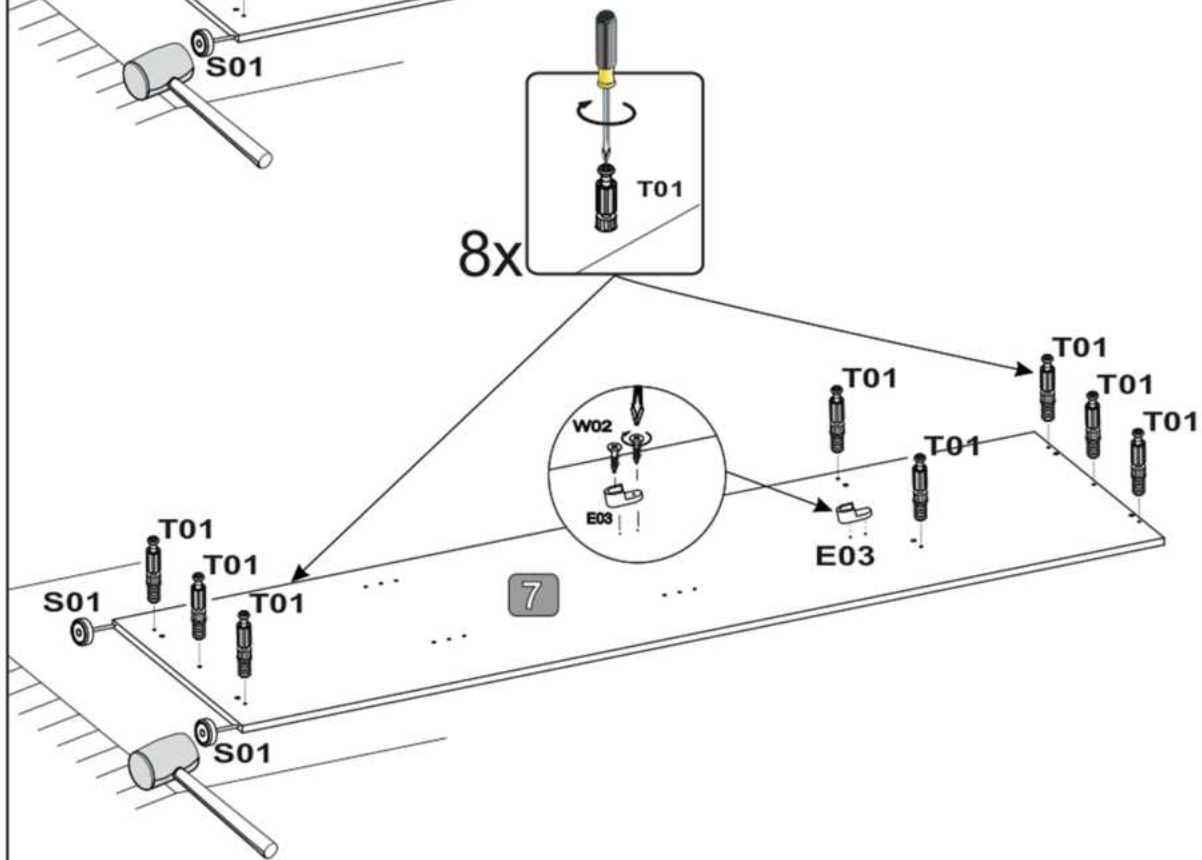
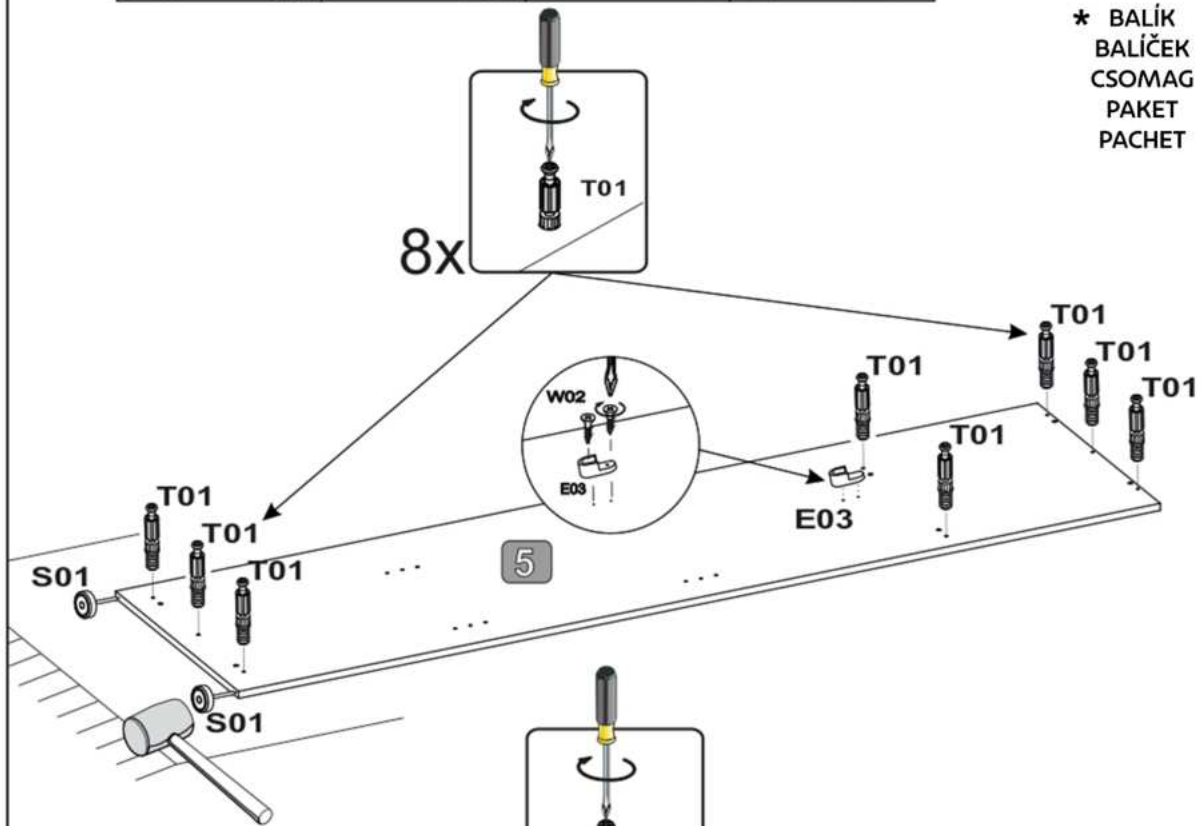

5 7

* BALÍK
BALÍČEK
CSOMAG
PAKET
PACHET



5

 8x28 4x D01	 4x T01	 2x E03	 3,5x13 4x W02
---	---	---	---

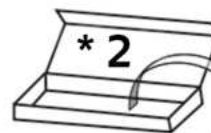

* BALÍK
BALÍČEK
CSOMAG
PAKET
PACHET

10

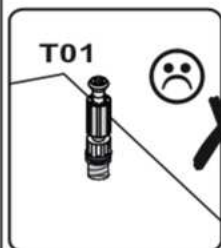
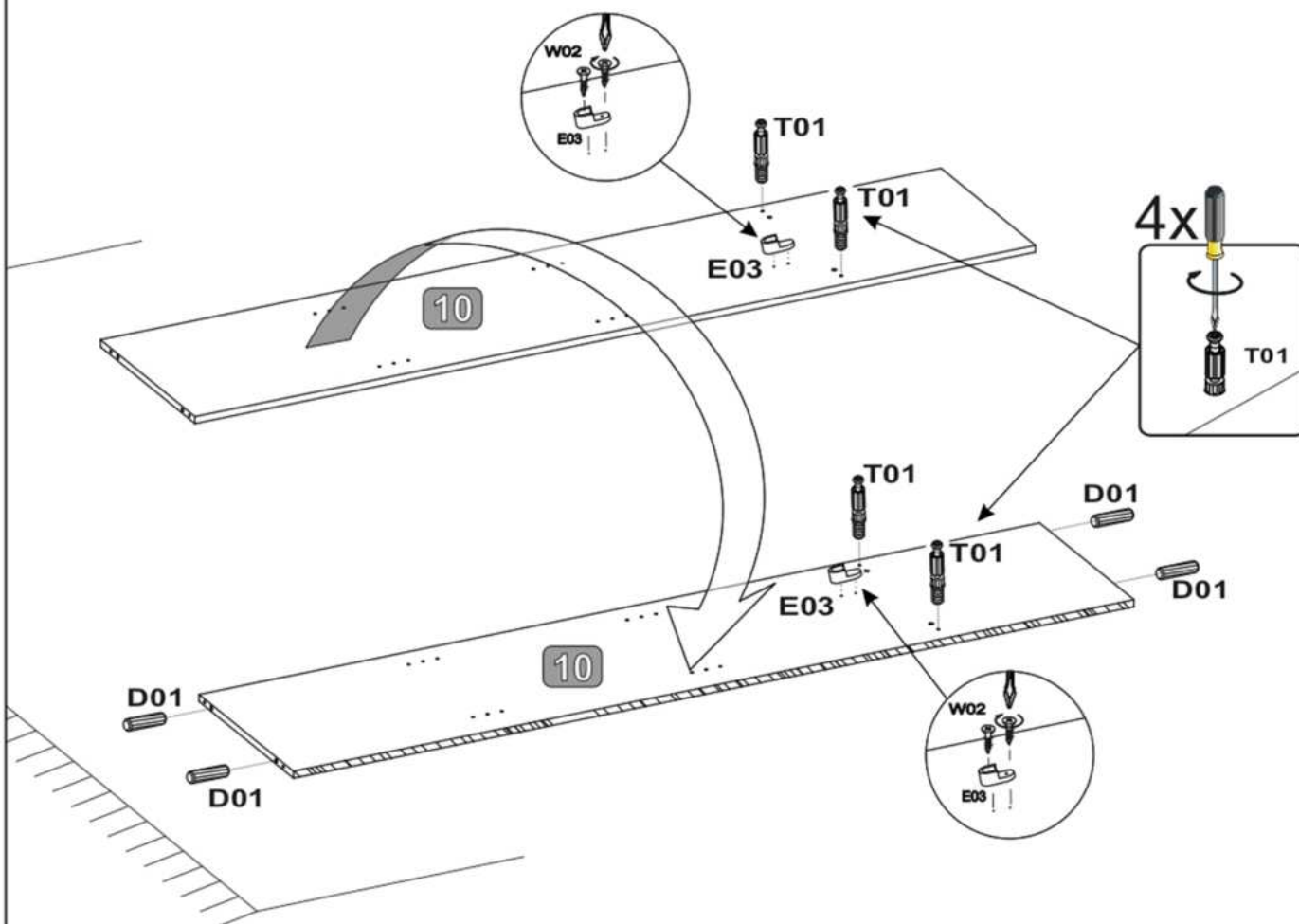

6

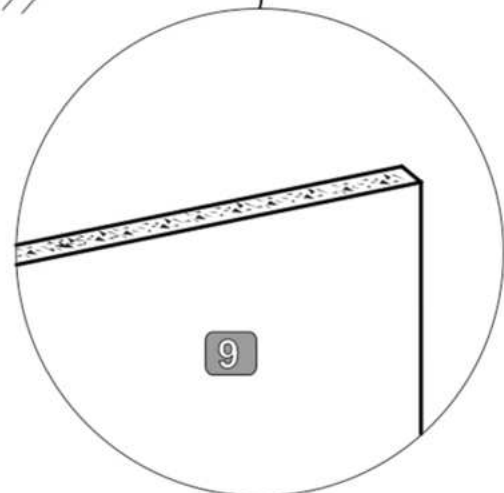
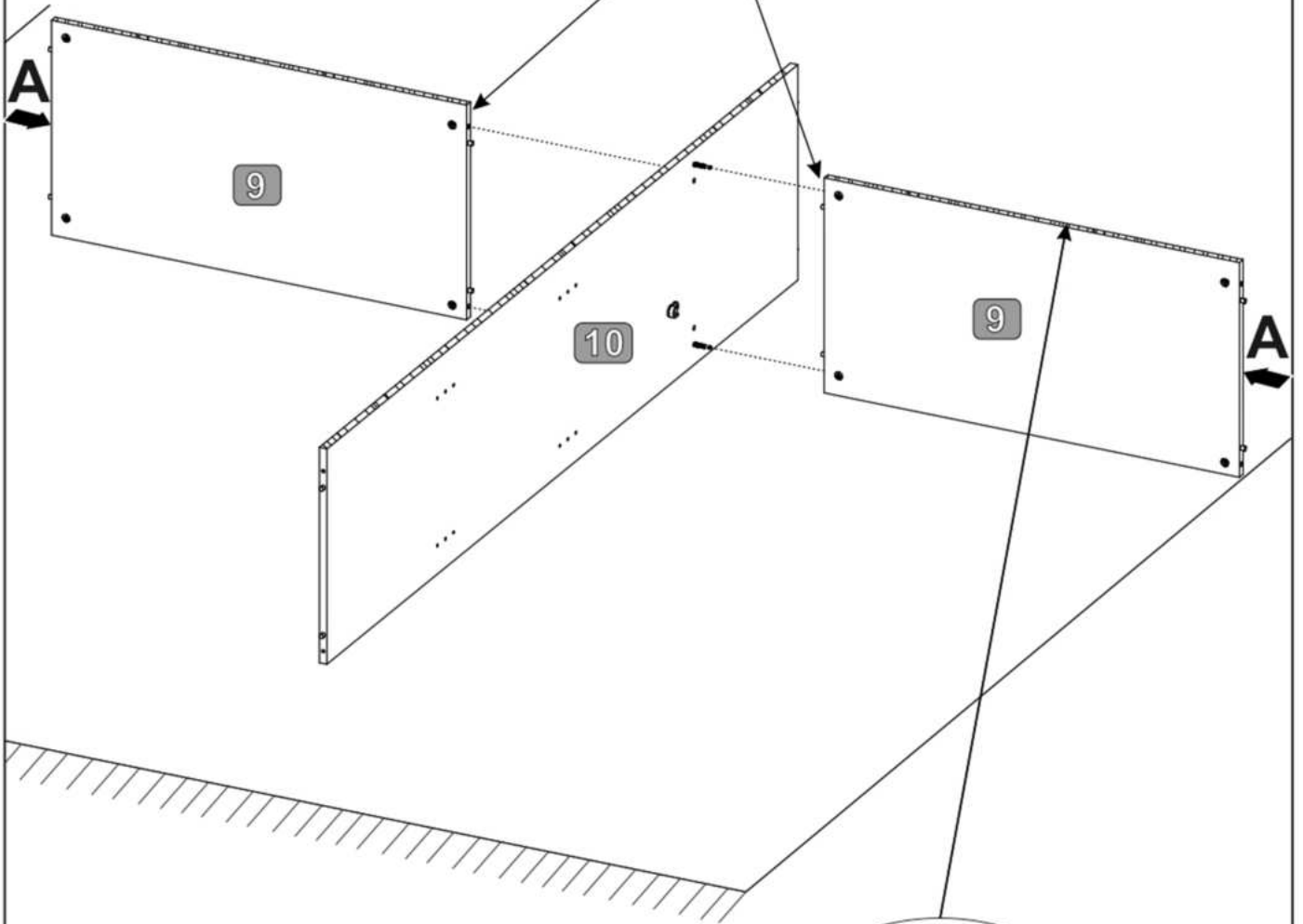
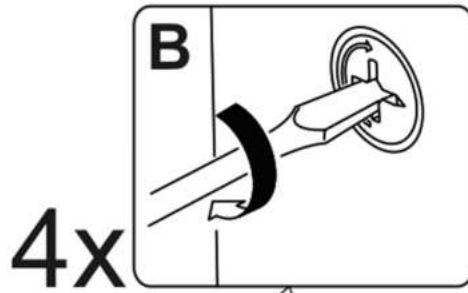

7

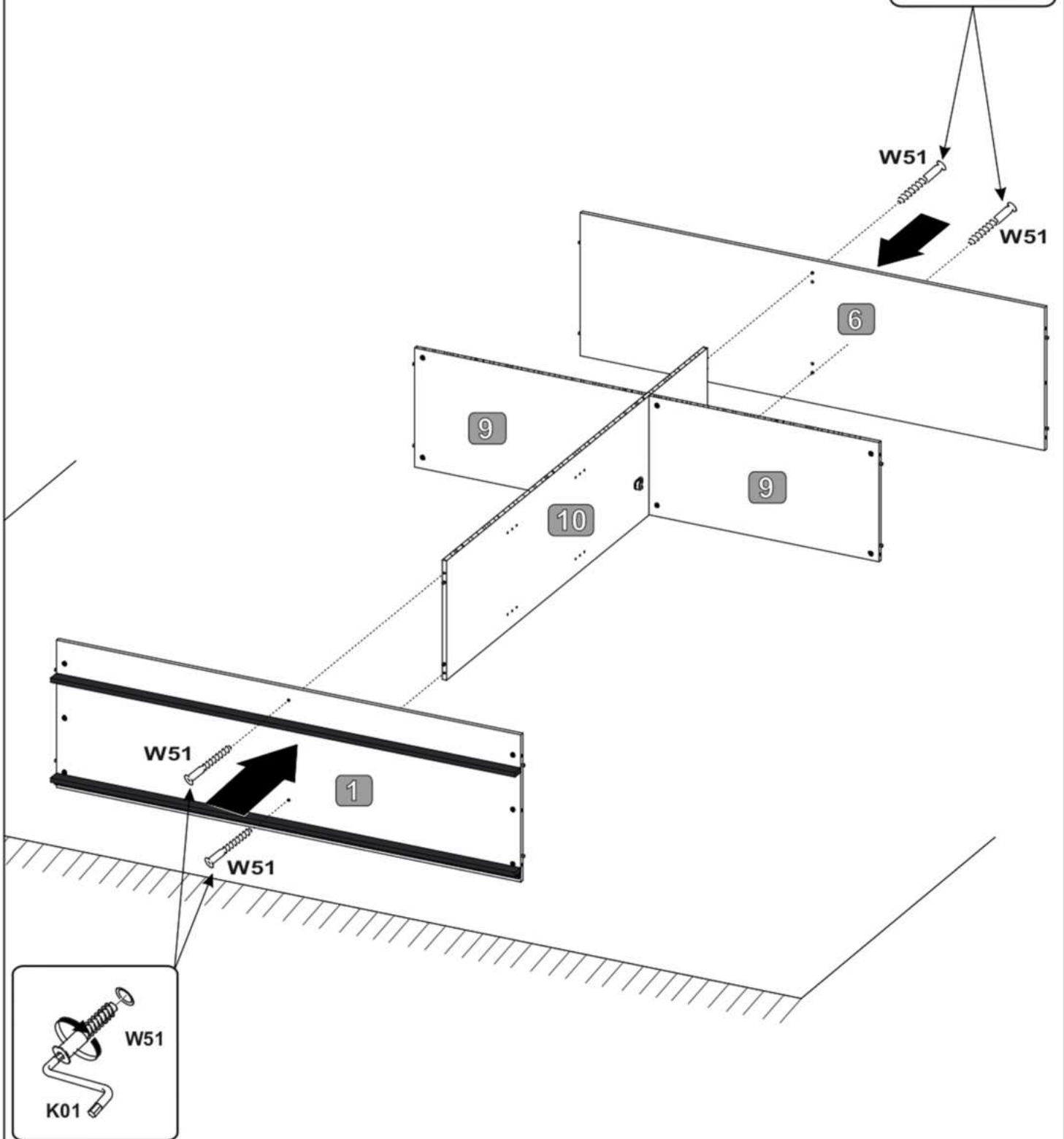
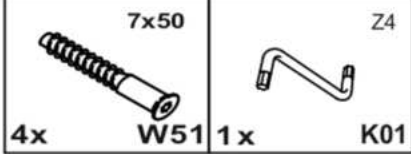

8

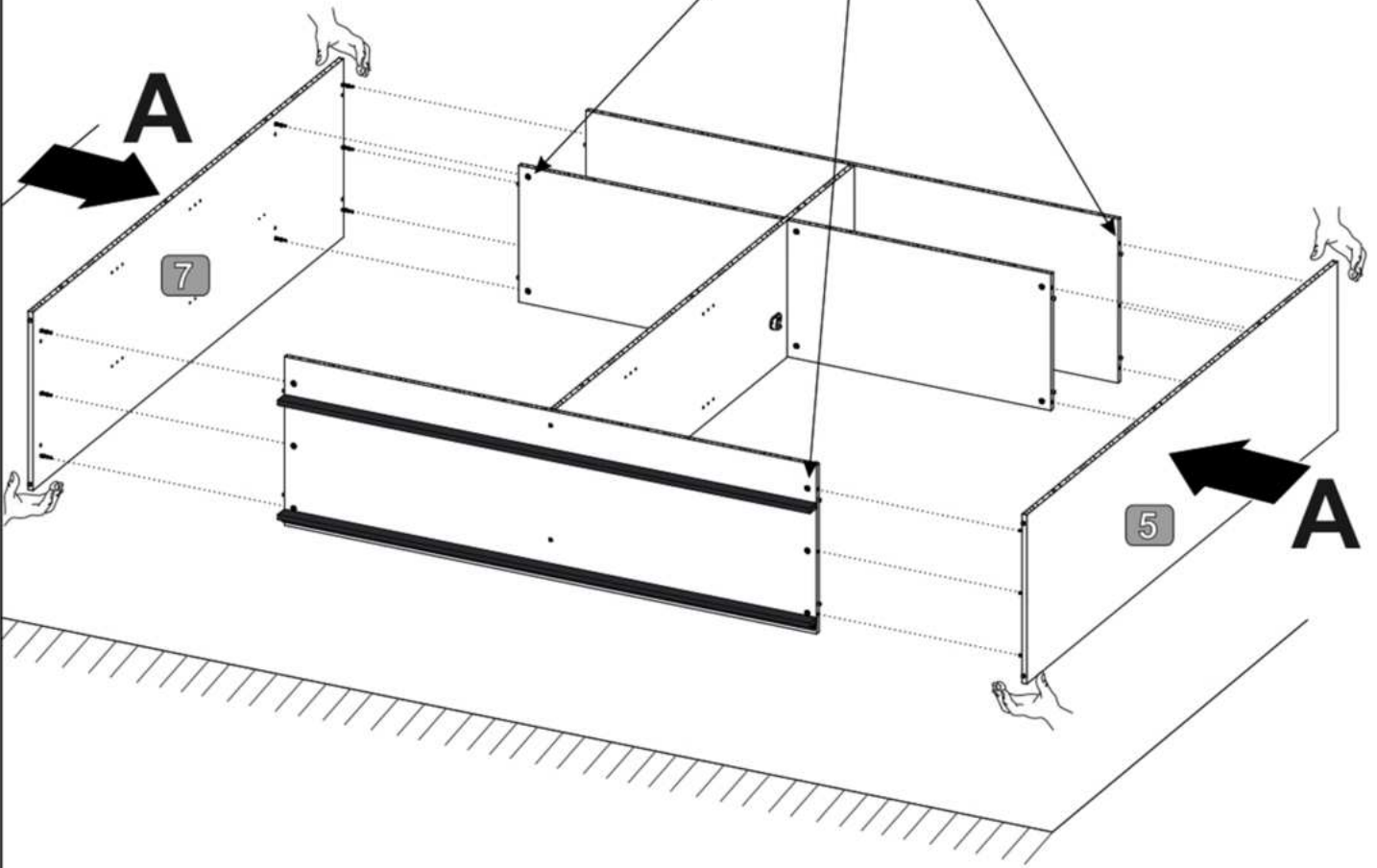
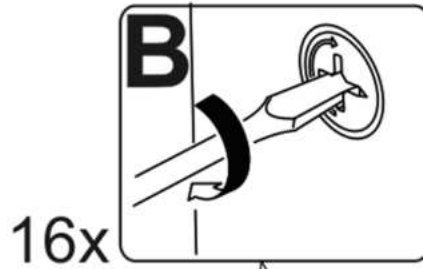

9

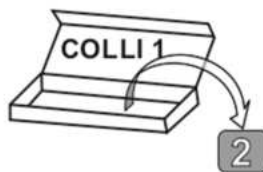
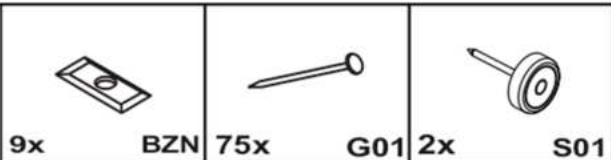

A=B

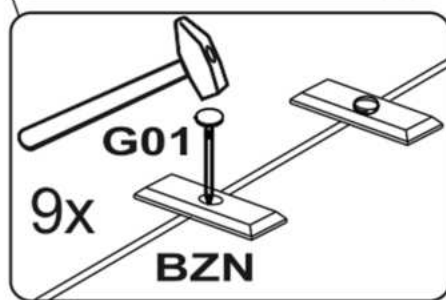
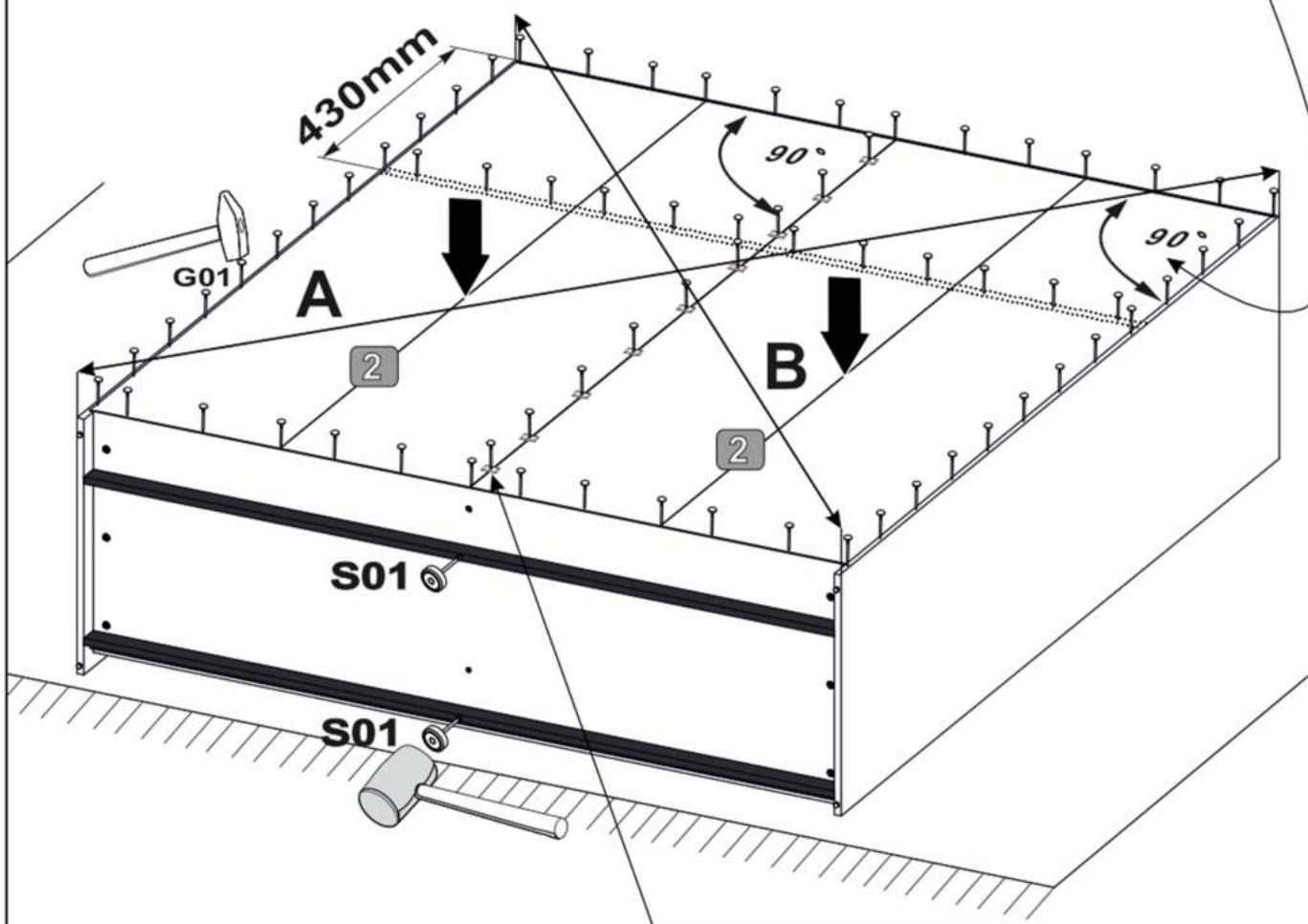
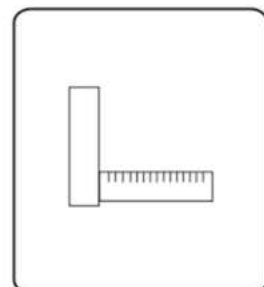

10

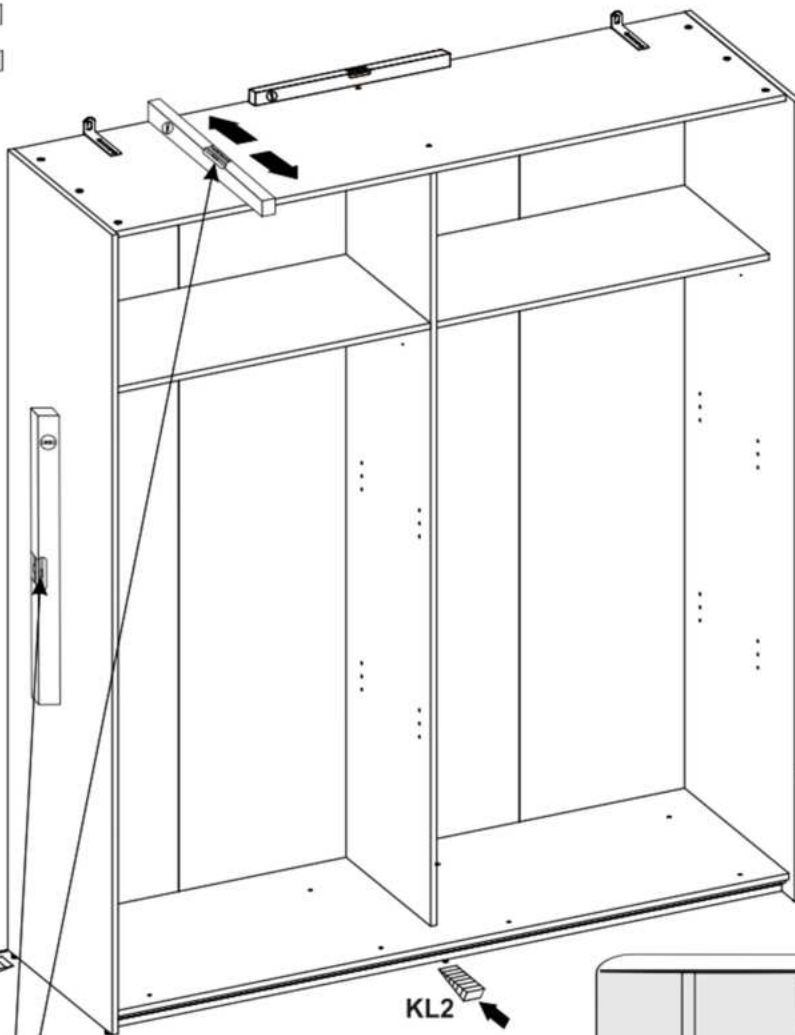
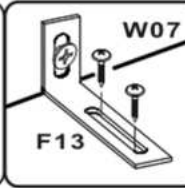
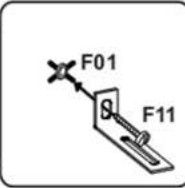
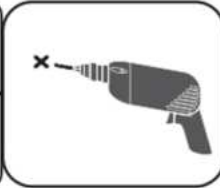
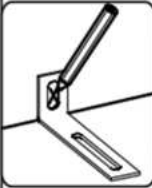
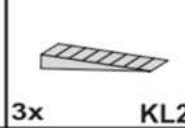
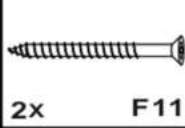
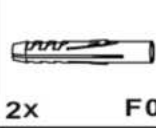

KL2

KL2

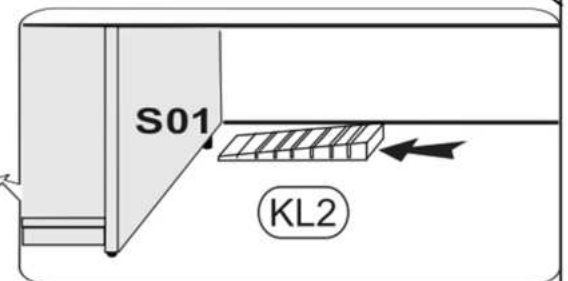

S01

KL2

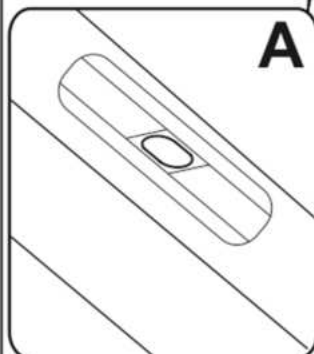

A

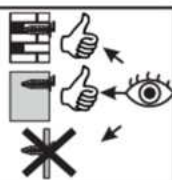
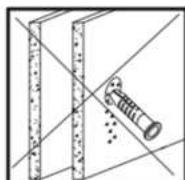
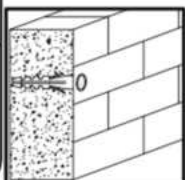

11

L-823



2x

J01

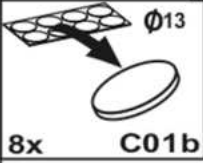

8x

C01b

C01b



8x

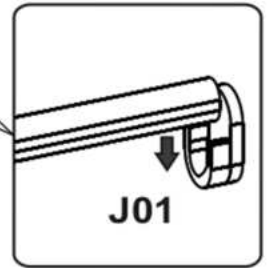
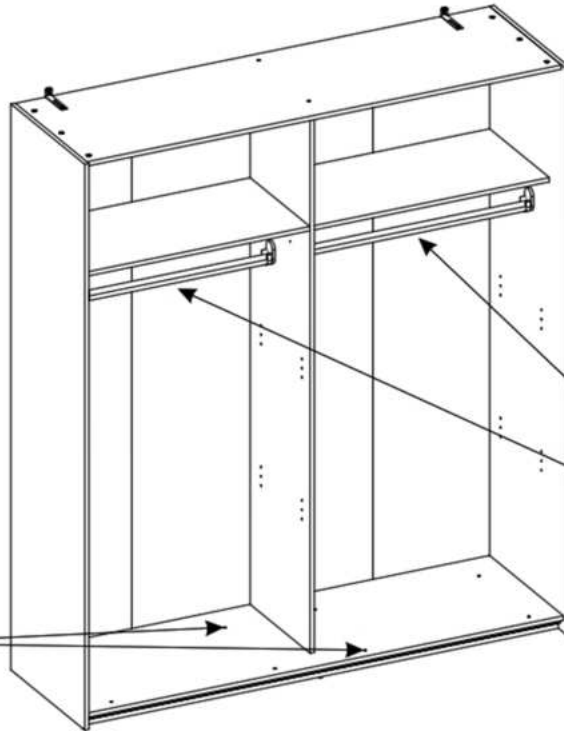

J01

12

3,5x25



4x

W36

2x



E05

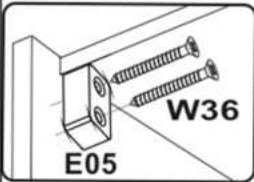

E05

W36

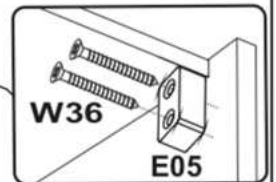

W36

E05

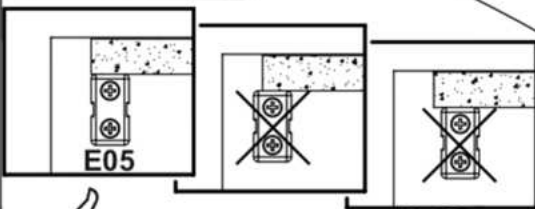

E05

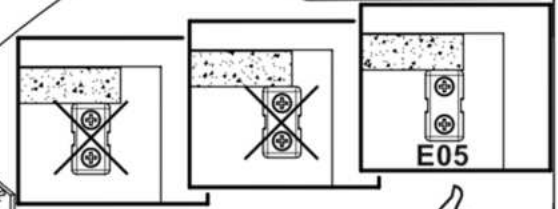

E05

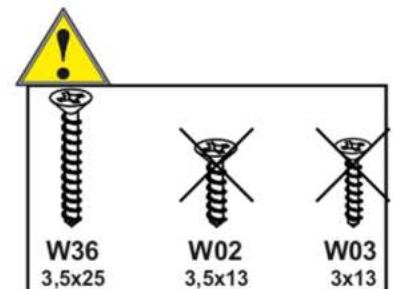
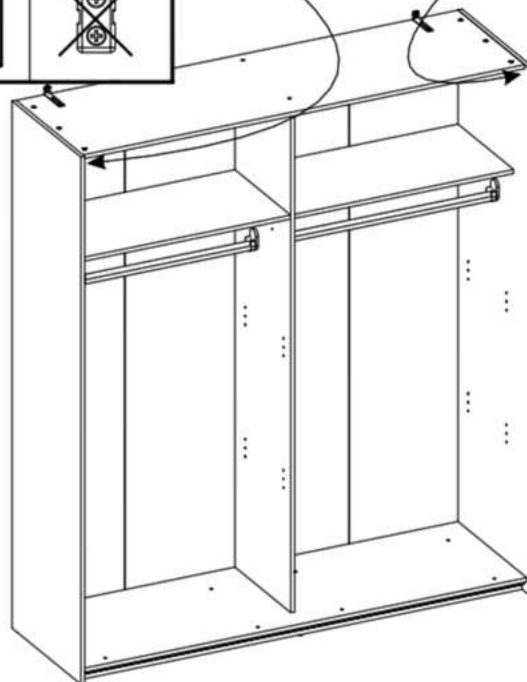
W36
3,5x25W02
3,5x13W03
3x13

13

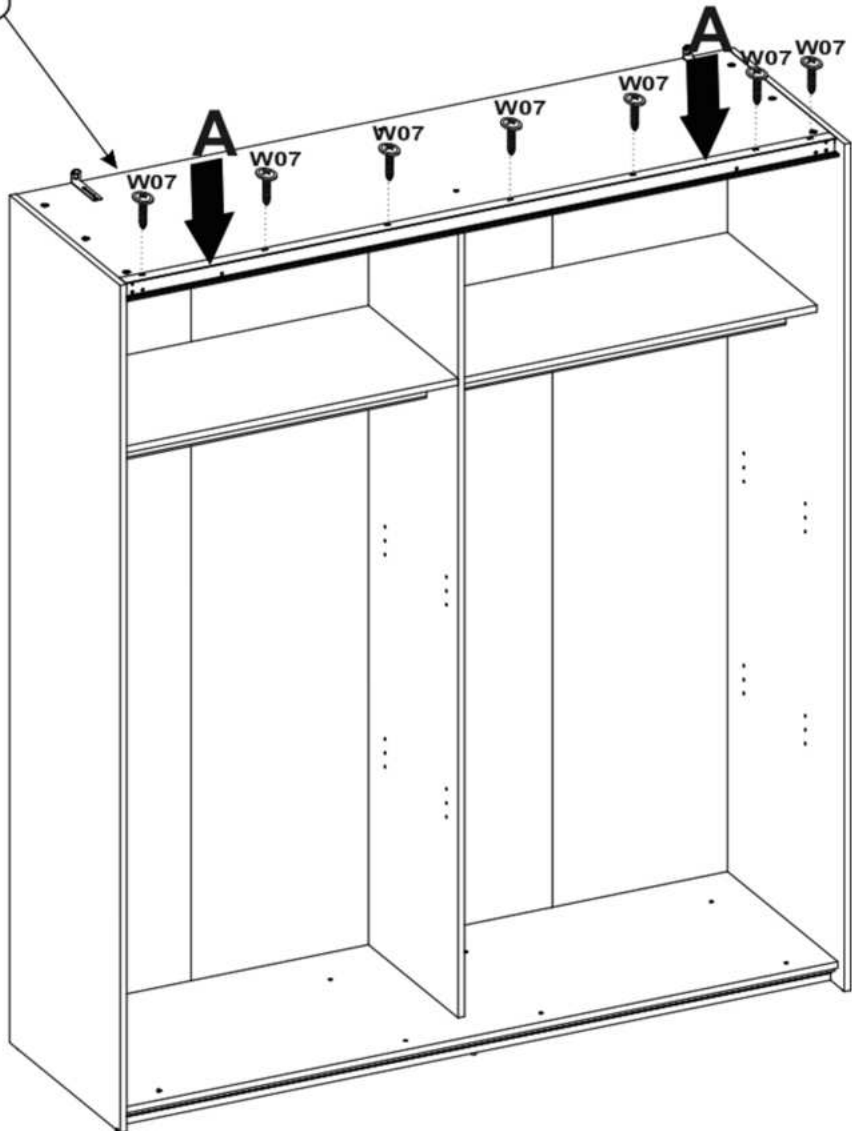
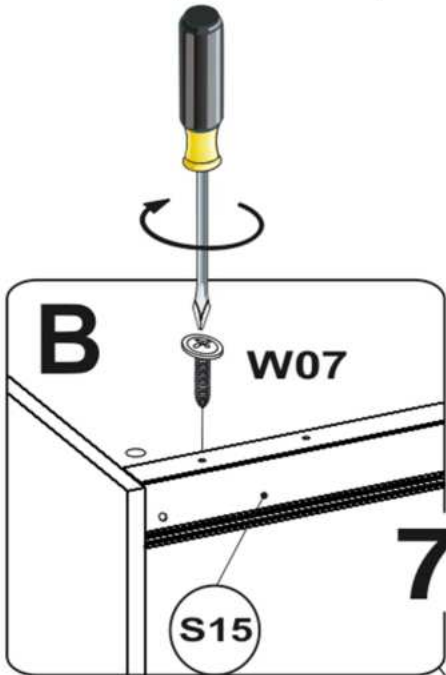
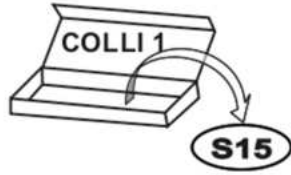
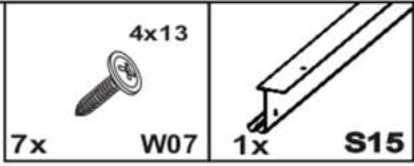

14



2X

E04



2X

W05S

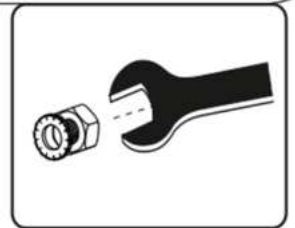
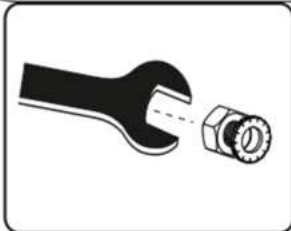
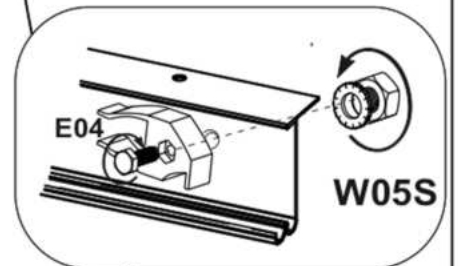
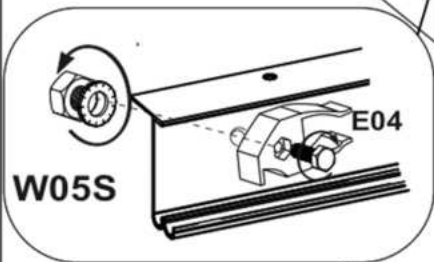
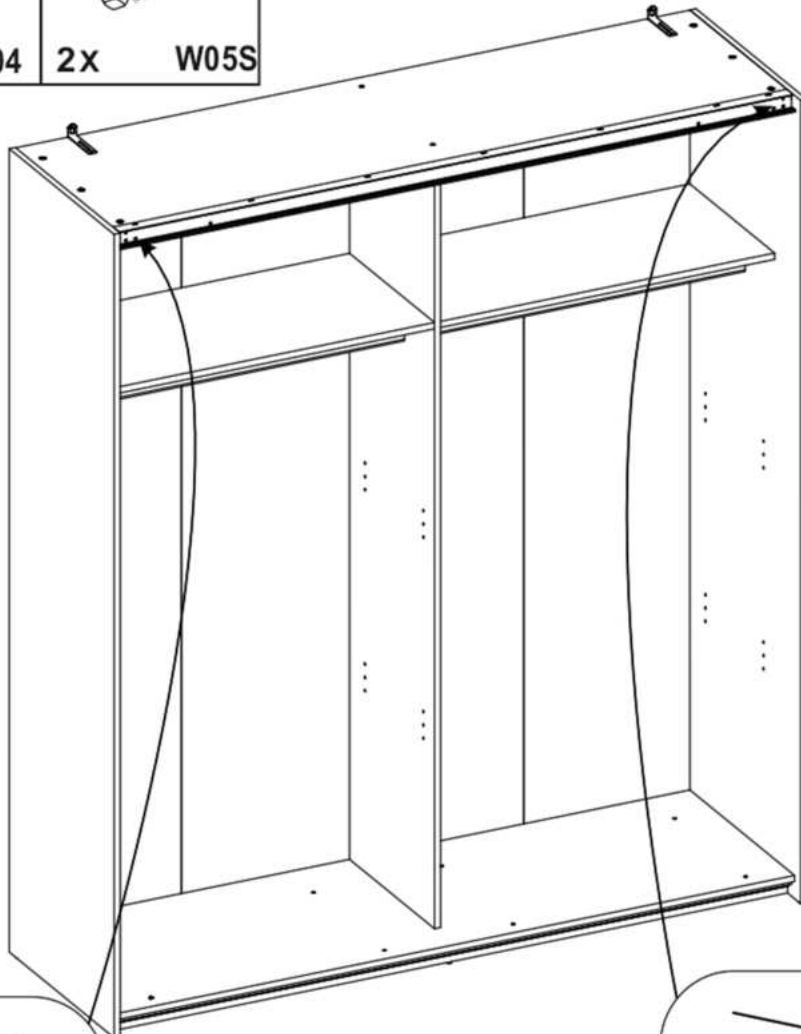

Ø8



Ø8



15

- 5x 3,5x13 W02
- 2x S10
- 1x S11
- 2x S14

- 4x13 W13
- 12x W13

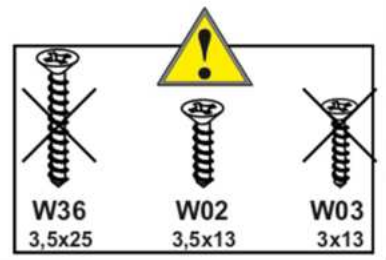
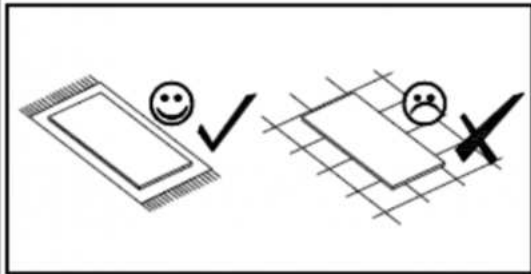
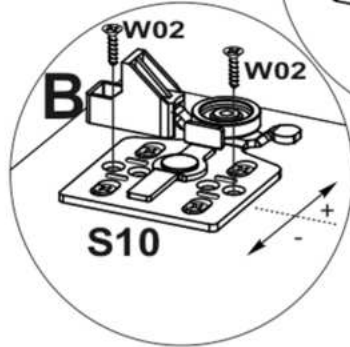
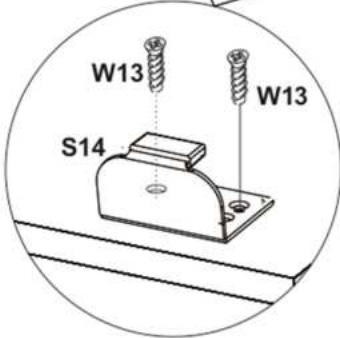
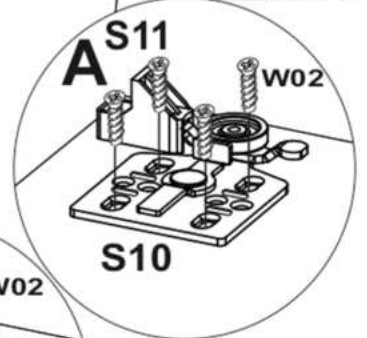
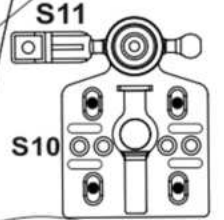
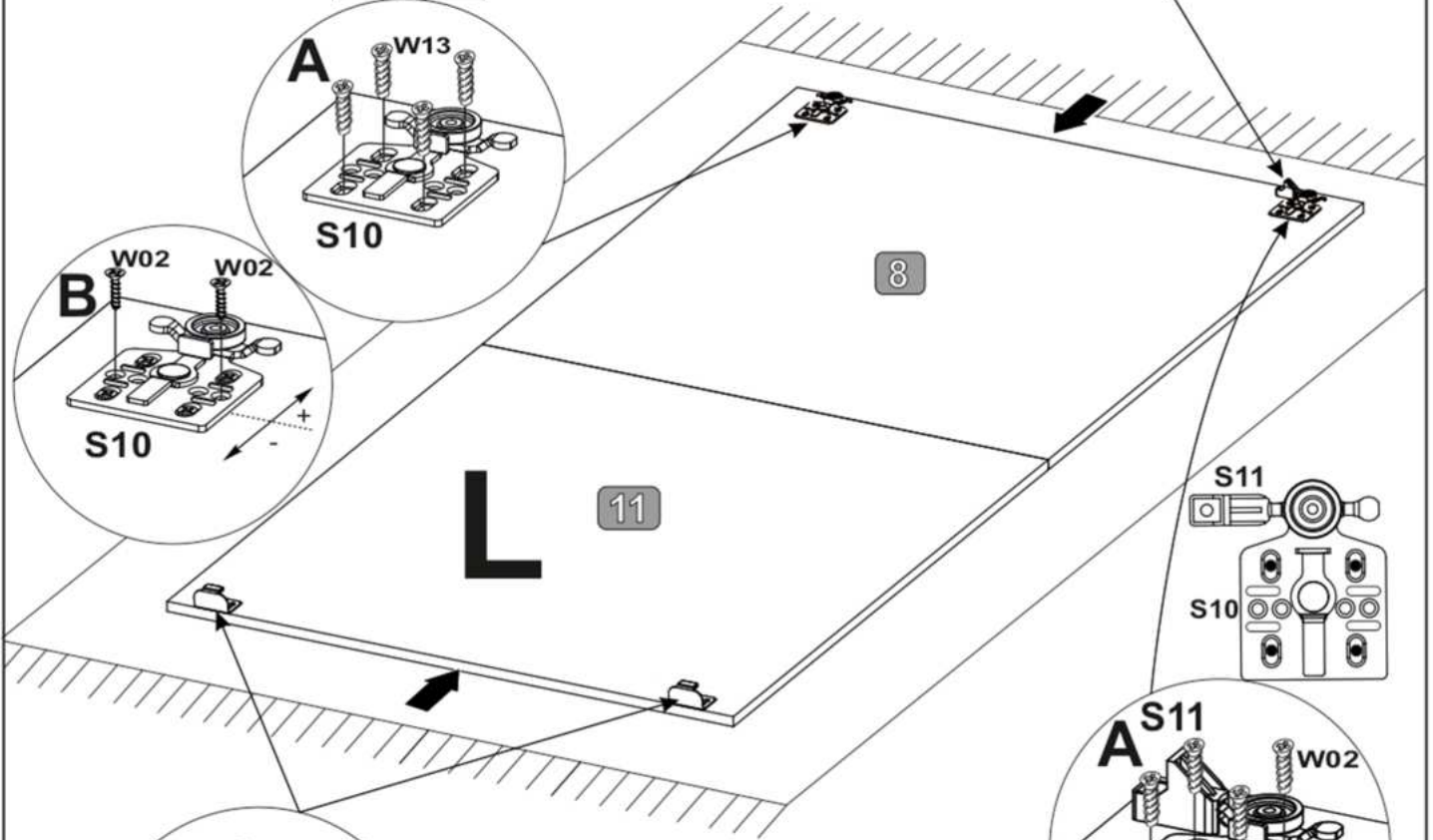
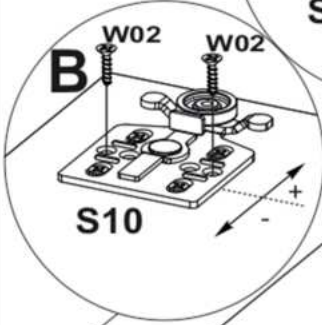
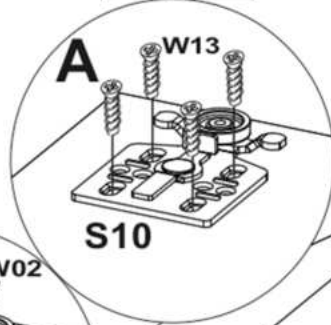
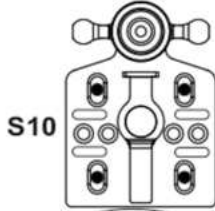
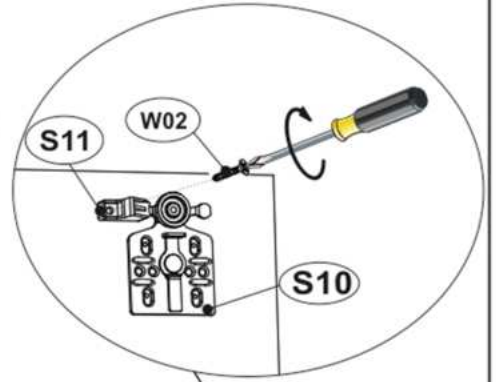
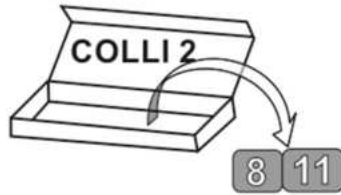

16

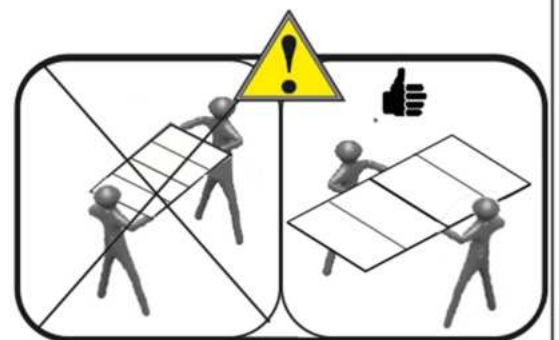
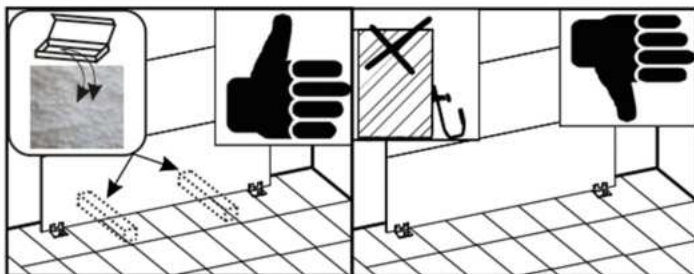
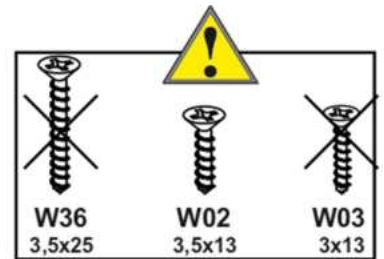
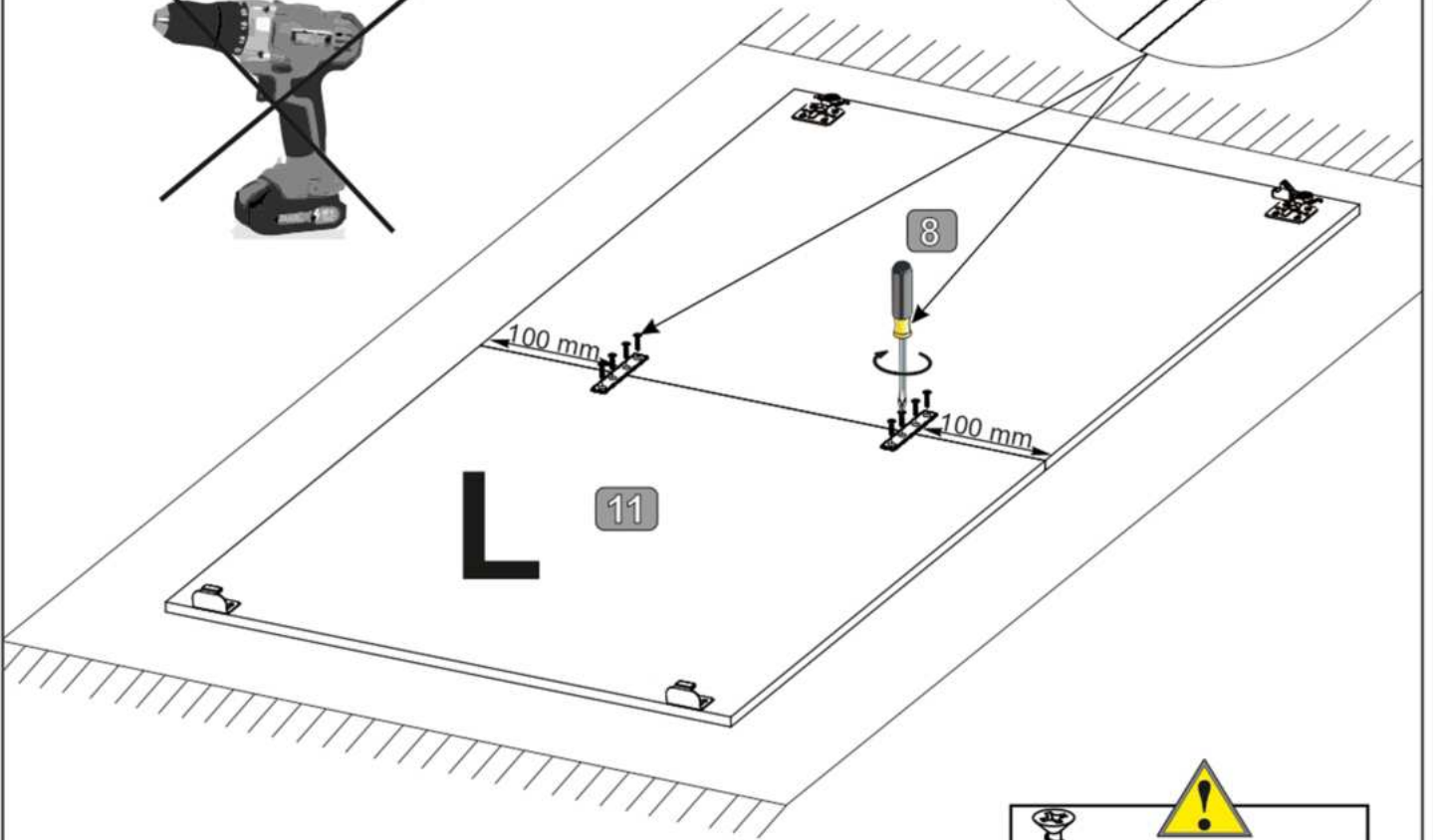
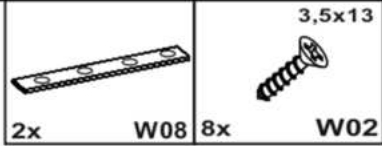

17

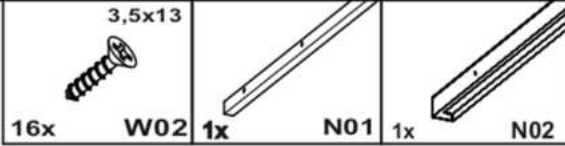

* BALÍK
BALÍČEK
CSOMAG
PAKET
PACHET

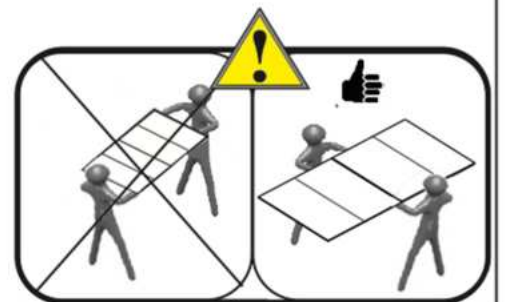
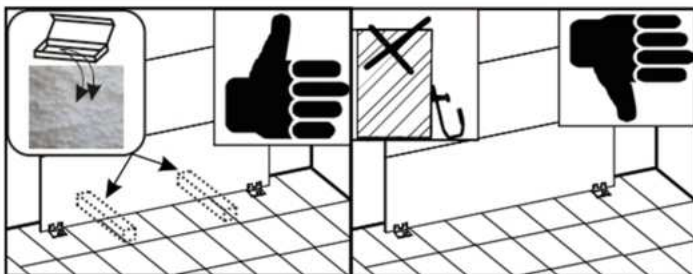
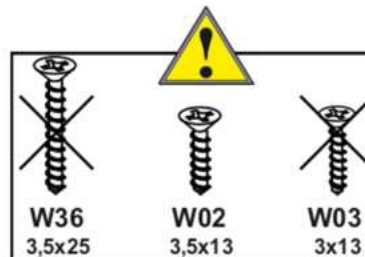
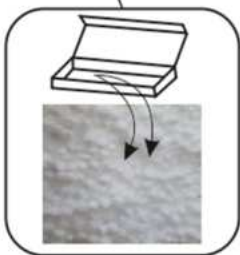
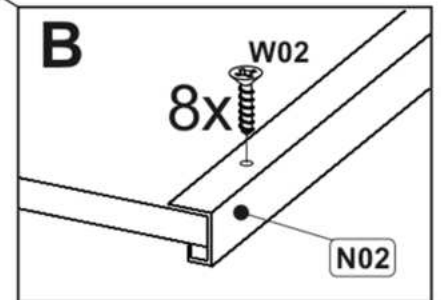
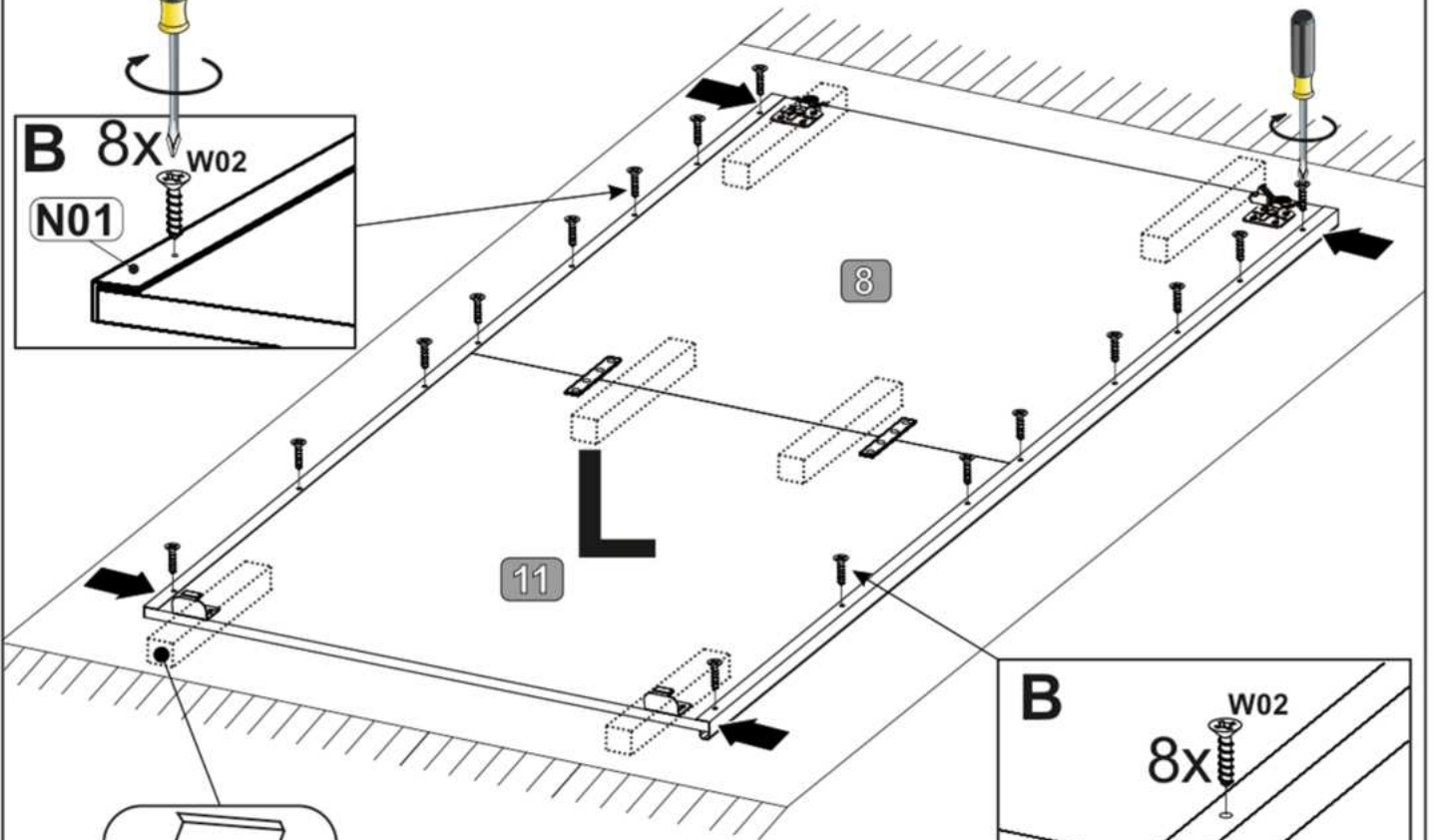
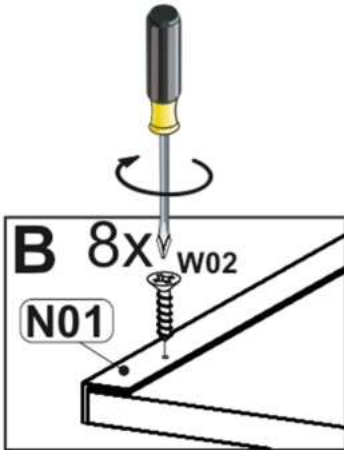
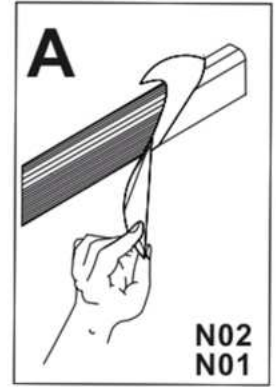
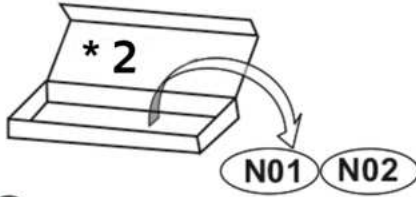

18

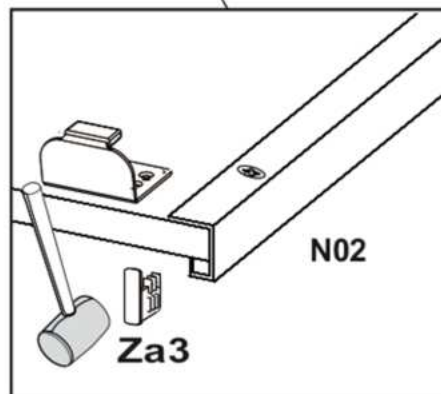
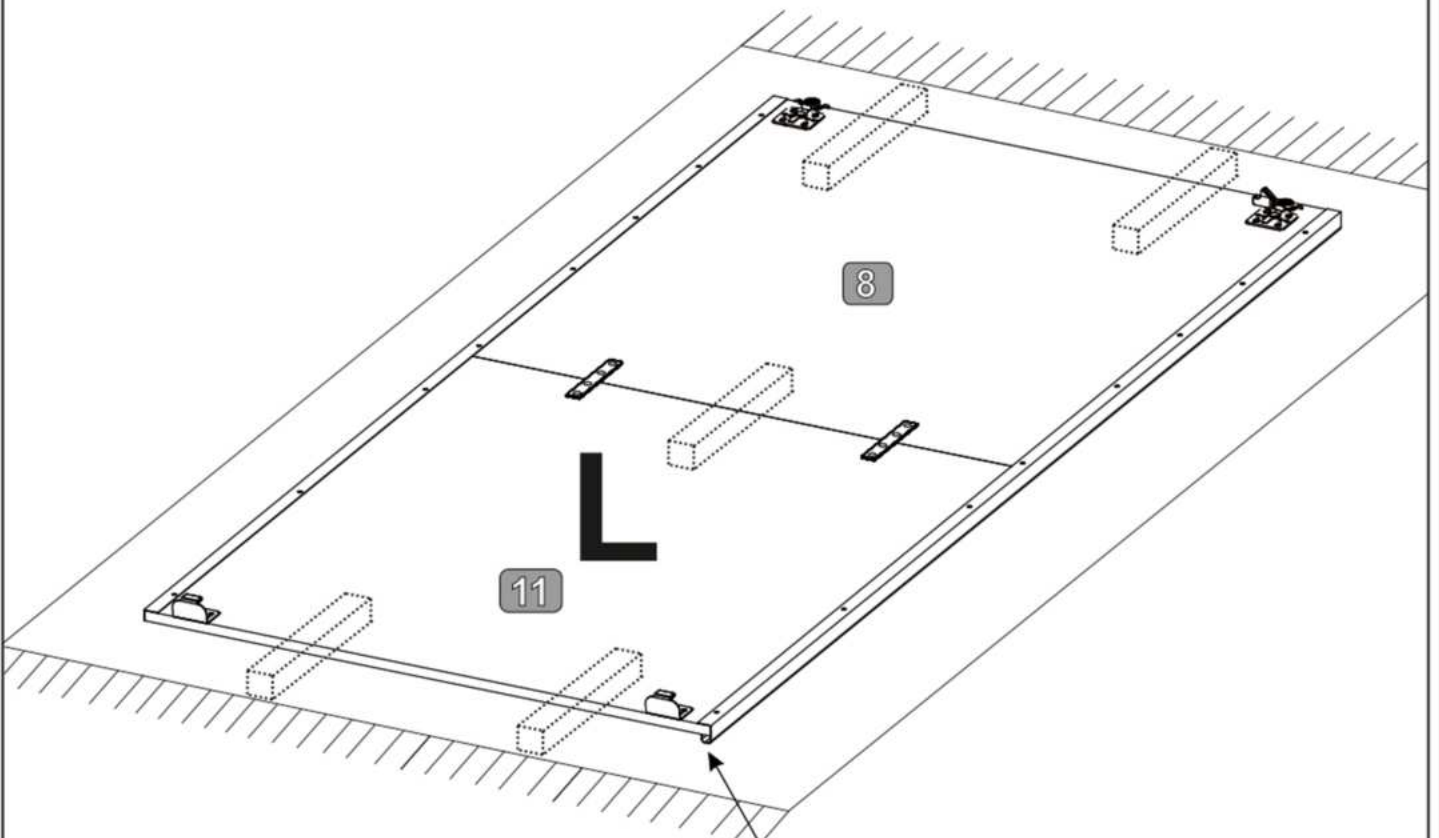

19

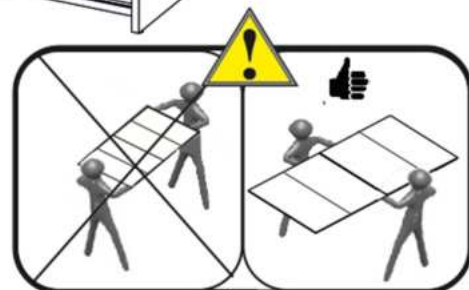
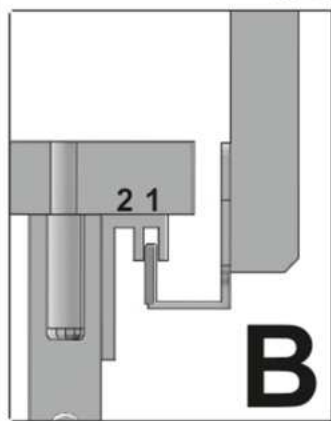
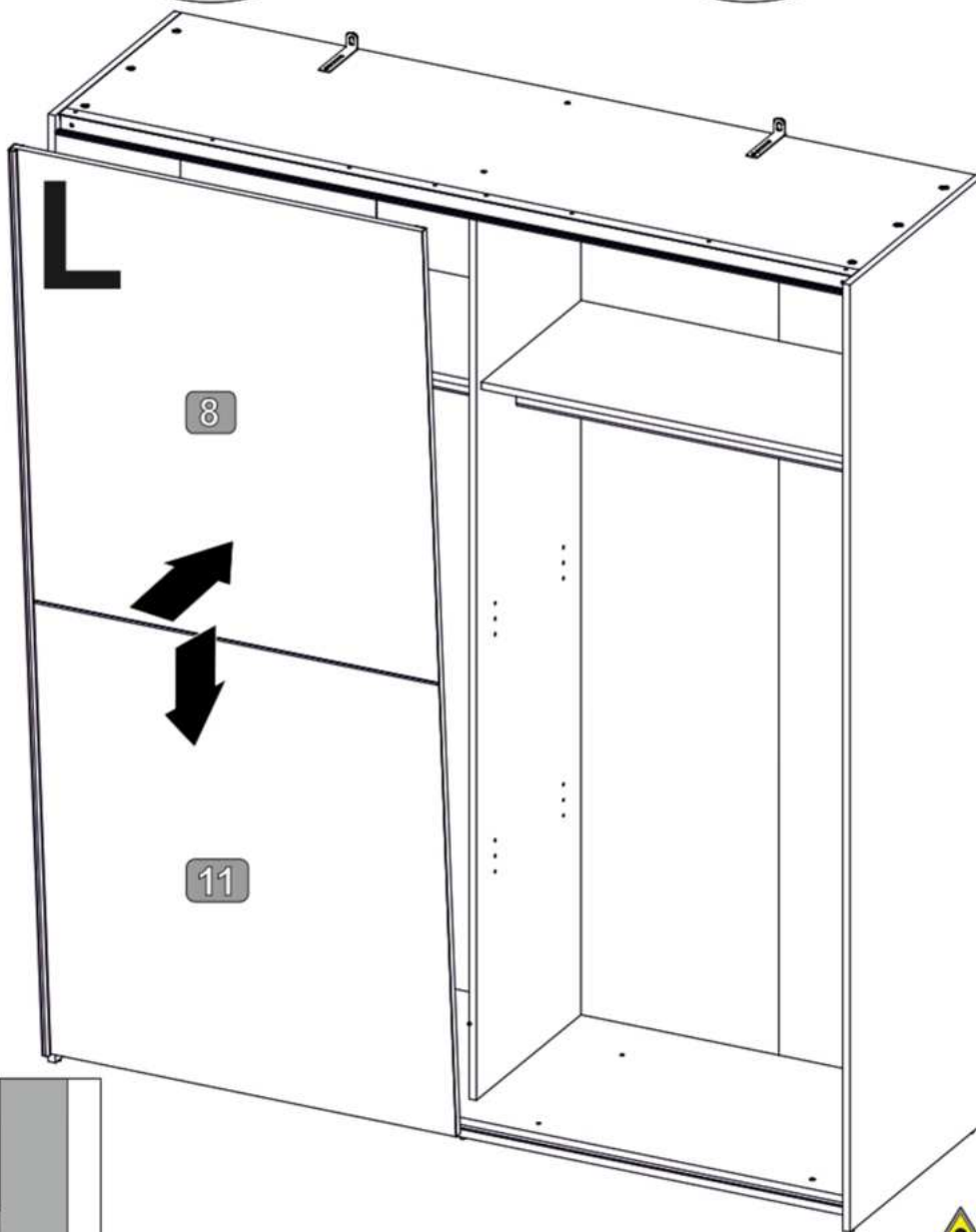
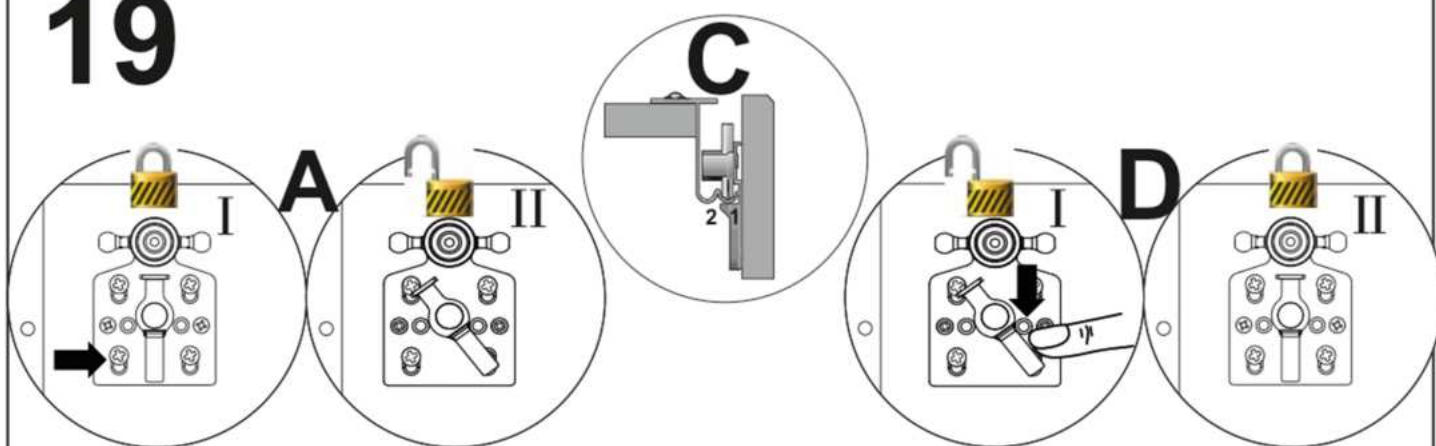

20

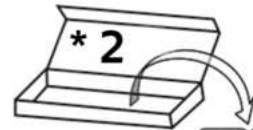
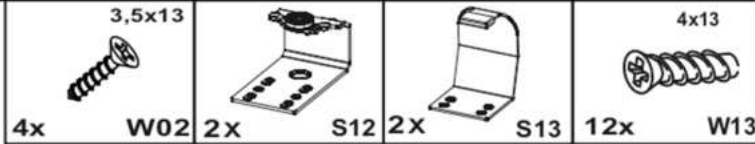

8 11

* BALÍK
BALÍČEK
CSOMAG
PAKET
PACHET

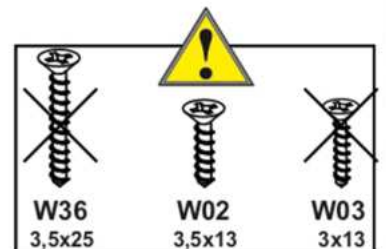
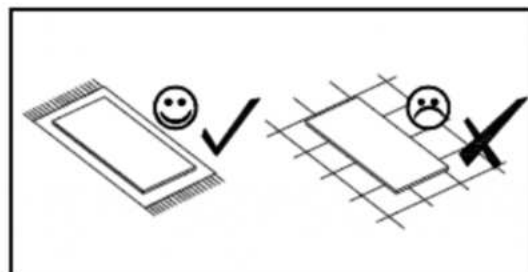
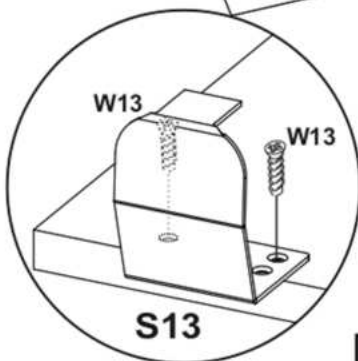
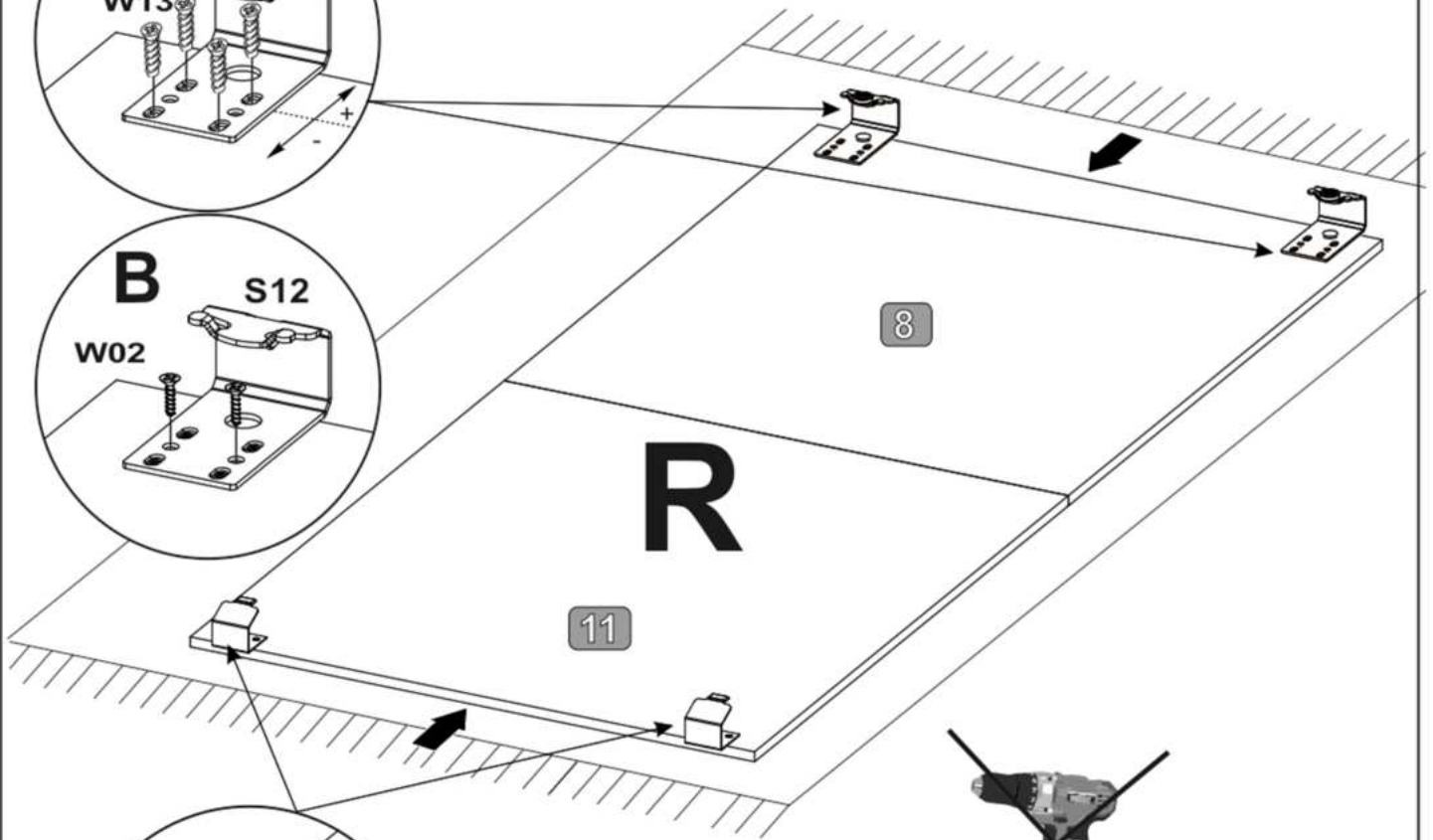
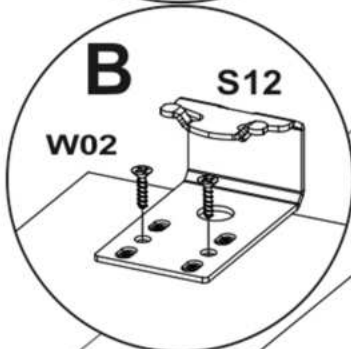
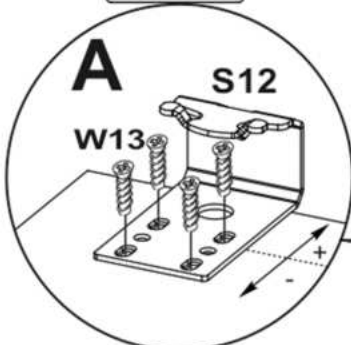
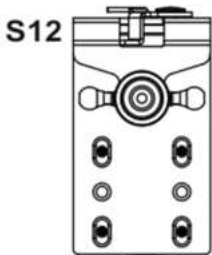

21

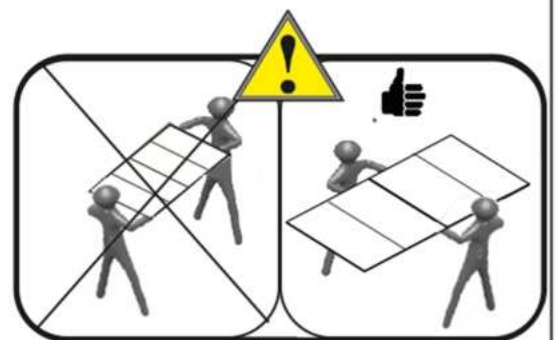
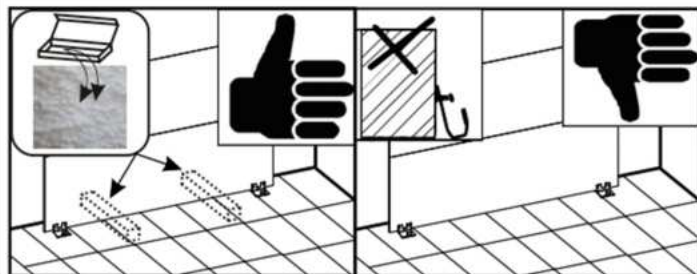
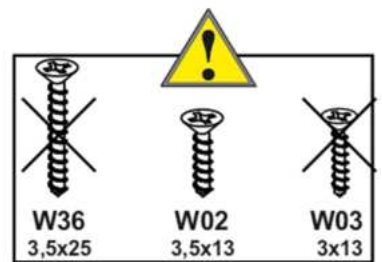
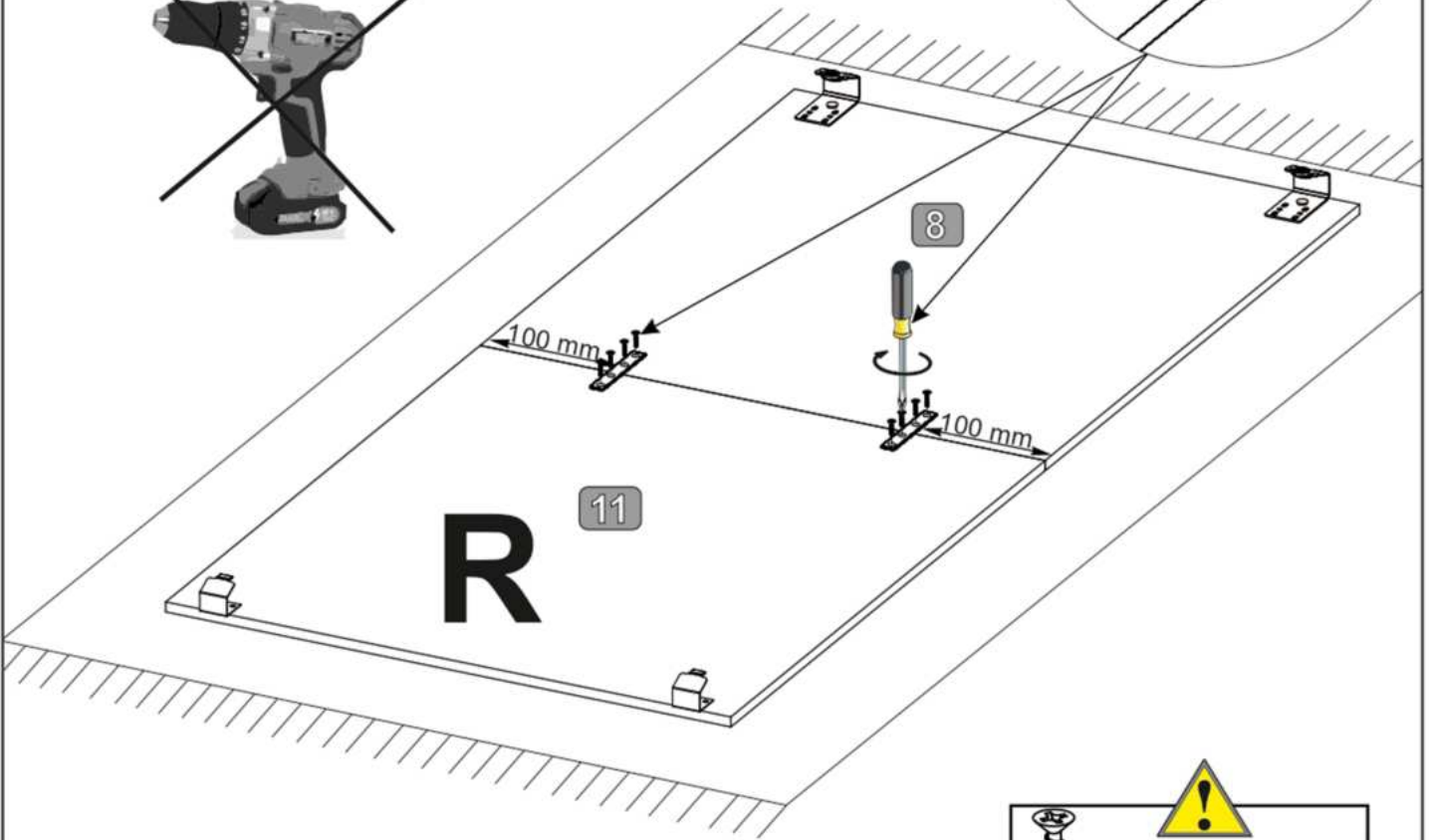
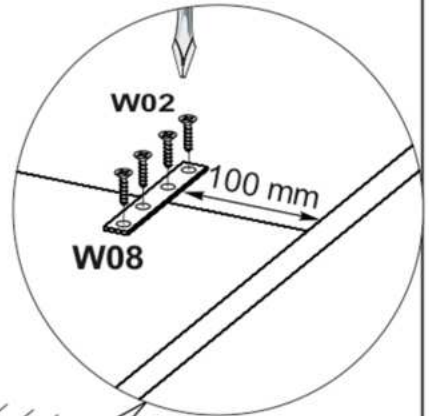
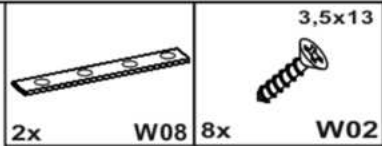

22

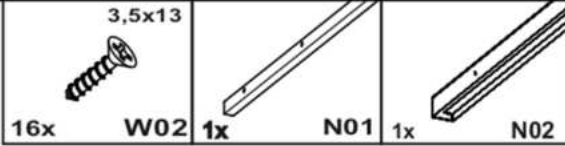

* BALÍK
BALÍČEK
CSOMAG
PAKET
PACHET

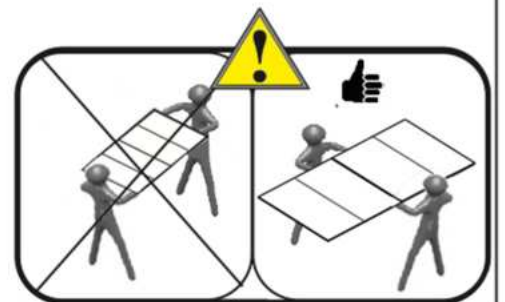
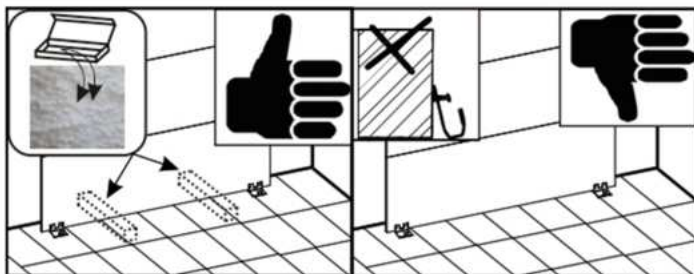
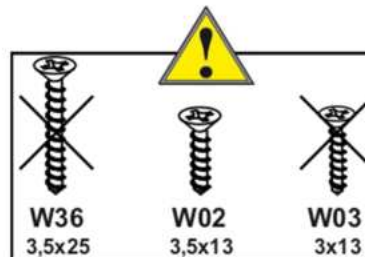
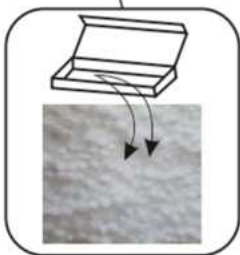
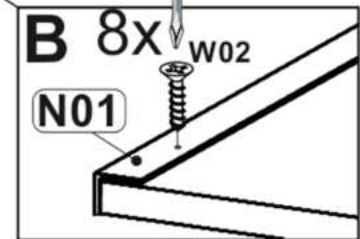
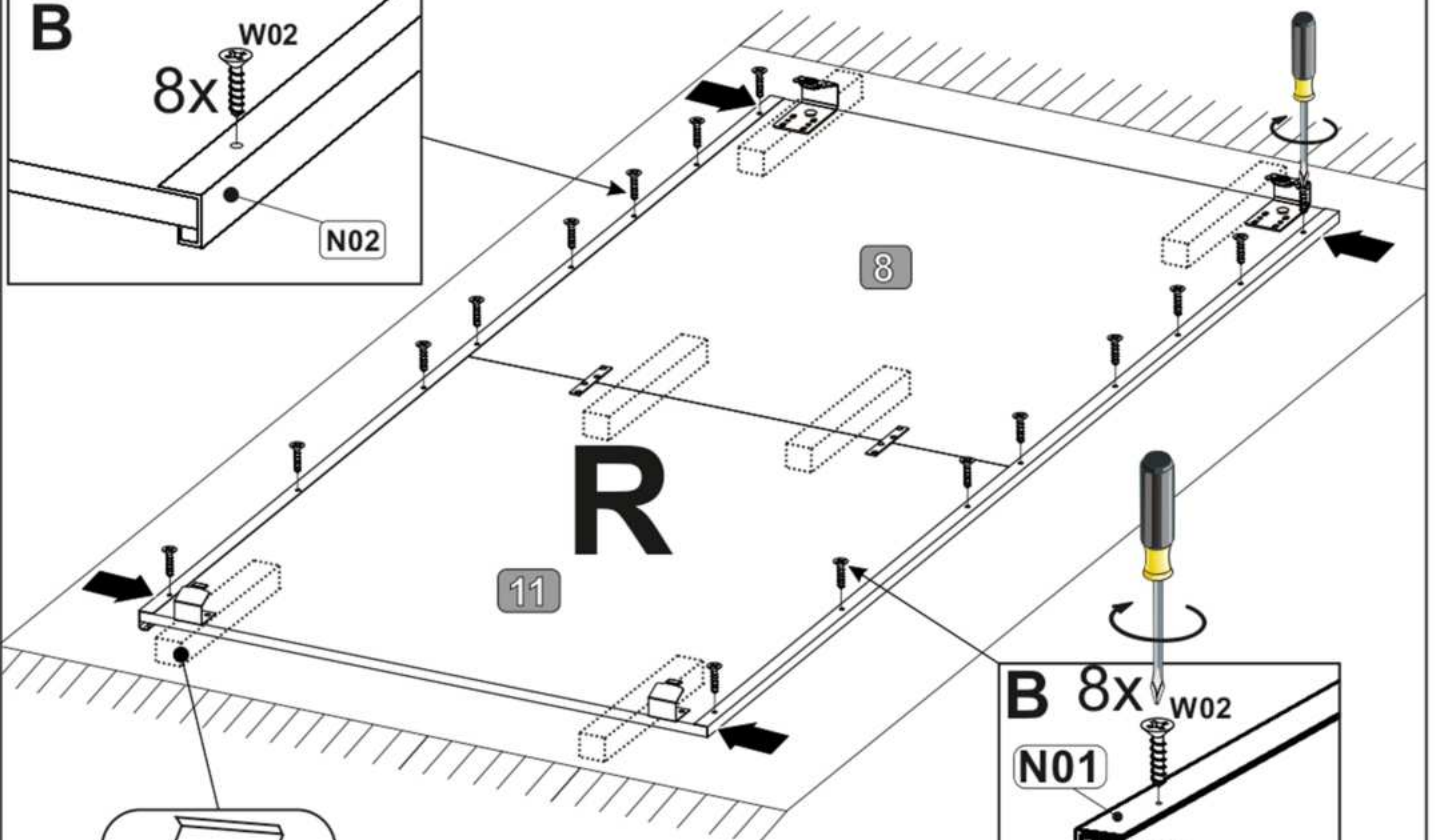
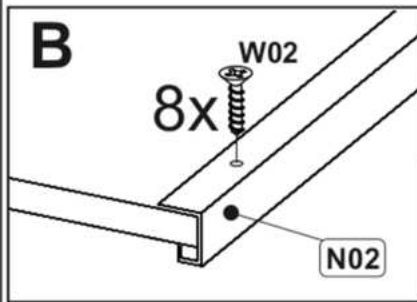
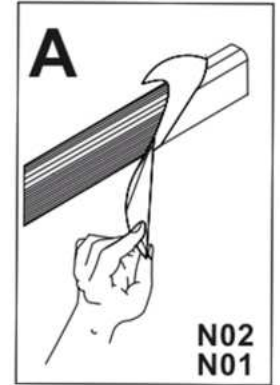
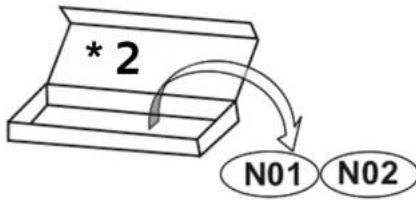

23

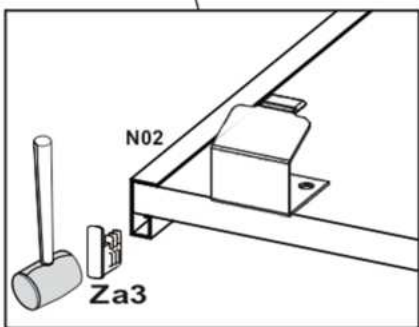
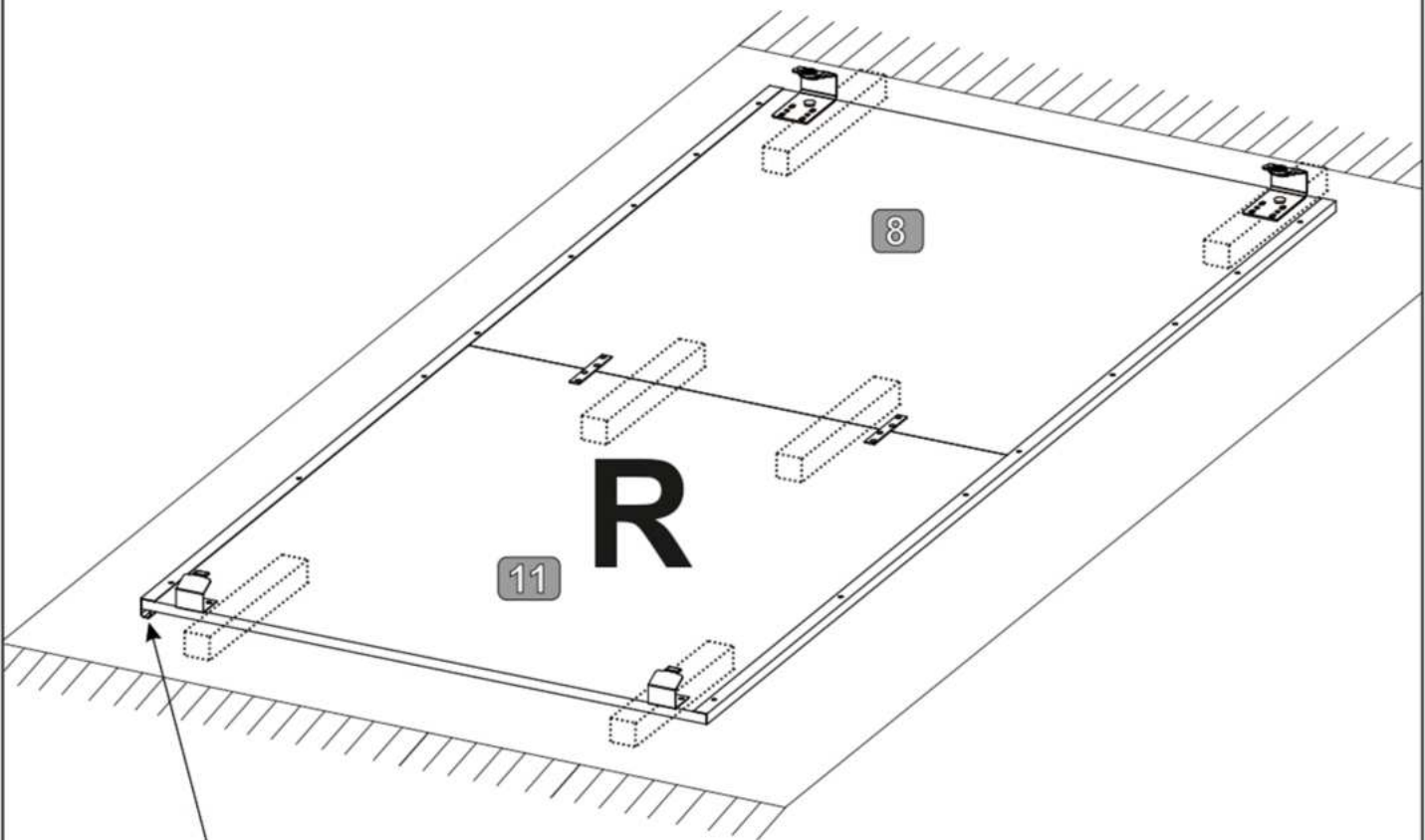
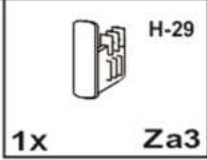

24

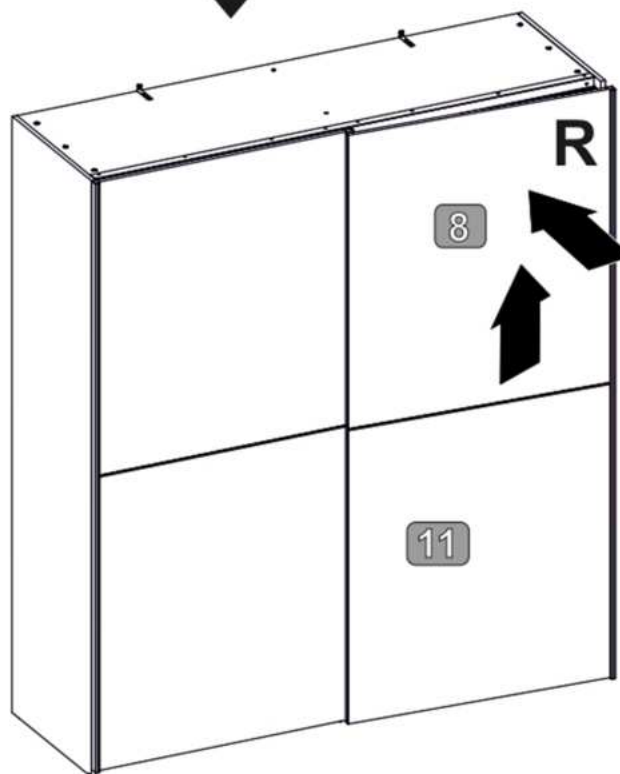
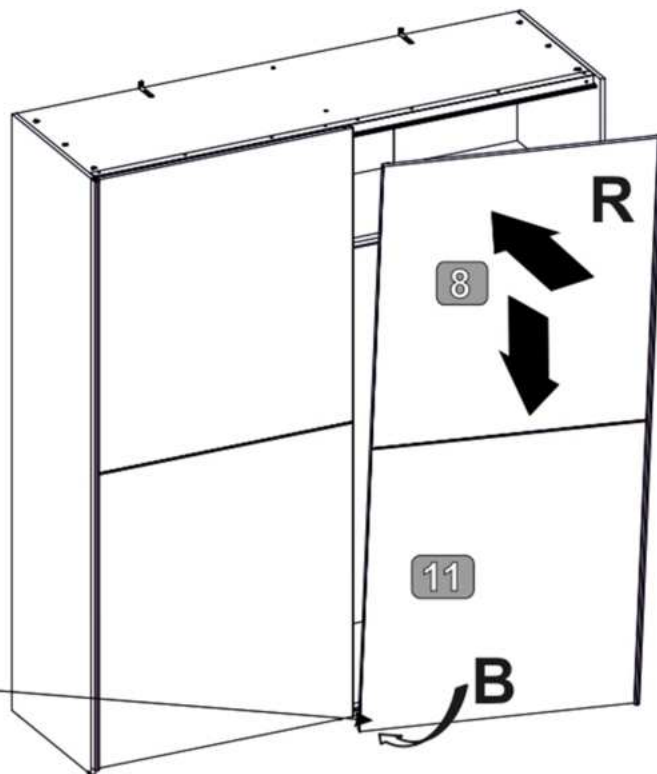
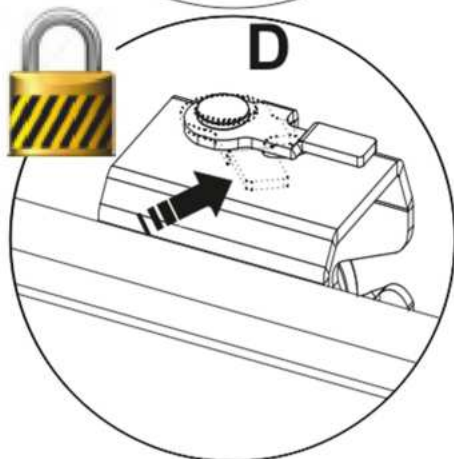
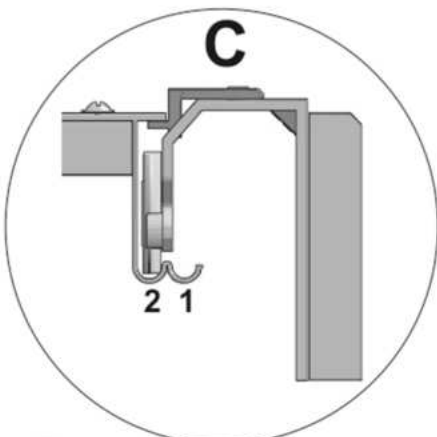
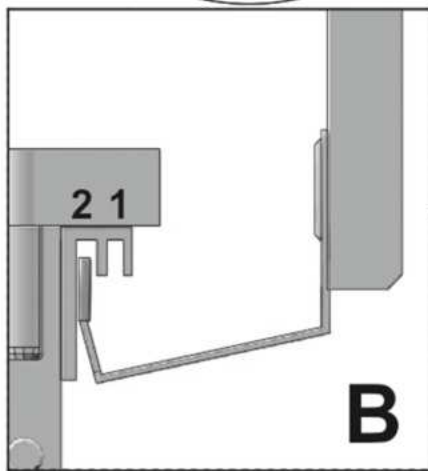
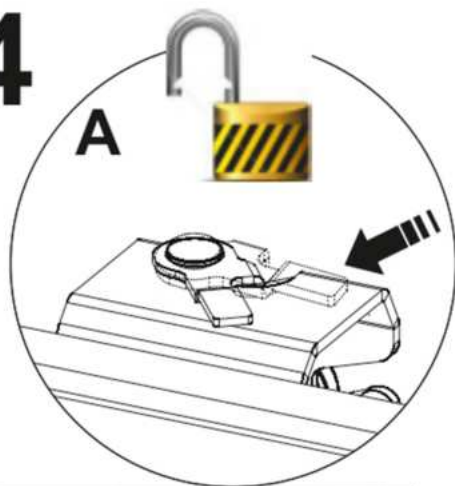

25

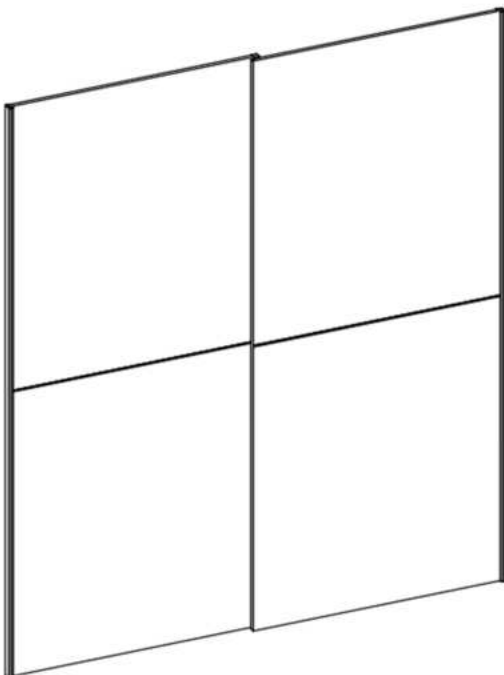
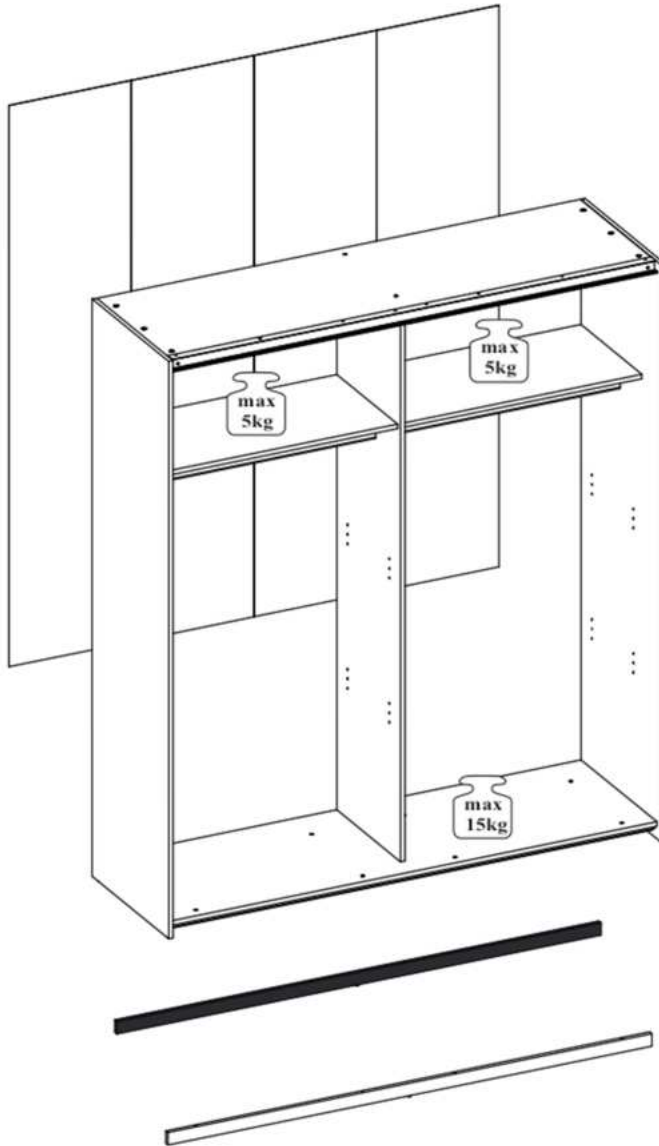

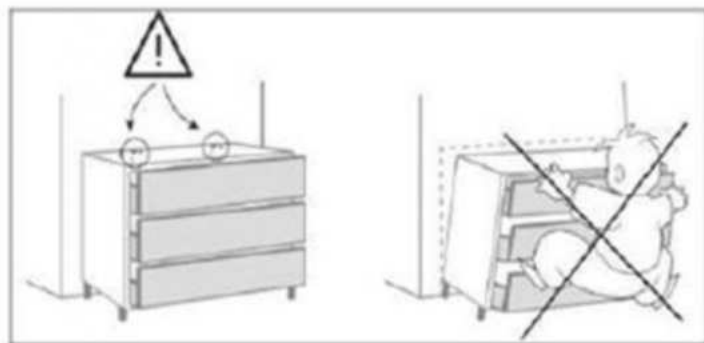
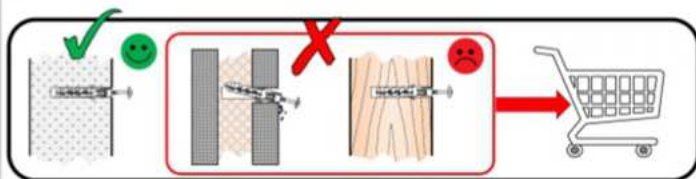
LE TRI
+ FACILE**SK - INFORMÁCIA O NEBEZPEČENSTVE:**

AK SÚ K TOVARU PRILOŽENÉ PRÍCHYTKY A SKRUTKY, SÚ URČENÉ VÝLUČNE NA POUŽITIE NA STENÁCH Z MASÍVNYCH A JEDNOTNÝCH MATERIÁLOV, ABY SA ZABRÁNILO PREVRÁTENIU. PRED VFTANÍM SA UISTITE, ŽE SA NA VÍTANOM MIESTE NENACHÁDZAJÚ ŽIADNE PLYNOVÉ, VODOVODNÉ ALEBO ELEKTRICKÉ VEDENIA. NA UPEVNENIE NA INÝCH STENÁCH MUSIA BYŤ POUŽITÉ ŠPECIÁLNE PRÍCHYTKY. SPÝTAJTE SA V PREDAJNI NA SKRUTKY A/ALEBO PRÍCHYTKY VHODNÉ PRE PRÍSLUŠNÝ TYP STENY. VÝROBCA NEPREBERÁ RUČENIE ZA NESPRÁVNU MONTÁŽ A TÝM VZNIKNUTÉ ŠKODY. VŠETKY SKRUTKY V PRAVIDELNÝCH INTERVALOCH KONTROLUJTE A DOTIAHNITE.

CZ - VÝSTRAŽNÉ UPOZORNĚNÍ:

POKUD JSOU K VÝROBKU PŘILOŽENY HMOŽDINKY A ŠROUBY, JSOU URČENY VÝHRADNĚ PRO POUŽITÍ DO STĚN ZHOTOVENÝCH Z MASIVNÍCH A HOMOGENNÍCH MATERIÁLŮ, A TO ZA ÚČELEM ZAJIŠTĚNÍ PROTI PŘEVRÁCENÍ. PŘED VRTÁNÍM SE UJISTĚTE, ŽE SE V MÍSTĚ VRTÁNÍ NENACHÁZÍ VEDENÍ PLYNU, VODY NEBO ELEKTRINY. PRO PŘIPEVNĚNÍ K JINÝM STĚNÁM JE NUTNÉ POUŽÍT ŠPECIÁLNÍ HMOŽDINKY. INFORMUJTE SE V OBCHODĚ O HMOŽDINKÁCH A/NEBO ŠROUBECH VHODNÝCH PRO PŘÍSLUŠNOU STRUKTURU STĚNY. VÝROBCE NENESE ODPOVĚDNOST ZA NESPRÁVNOU MONTÁŽ A ZA ŠKODY JÍ ZPŮSOBENÉ. VŠECHNY ŠROUBY PRAVIDELNĚ KONTROLUJTE A DOTAHUJTE.

HU - FIGYELMEZTETÉS:

AMENNYIBEN A TERMÉK CSOMAGOLÁSA TIPLIKET ÉS CSAVAROKAT IS TARTALMAZ, AZOK KIZÁRÓLAG MASSZÍV, EGYSÉGES ANYAGBÓL KÉSZÜLT FALAKON HASZNÁLHATÓK, A FELBORULÁS MEGAKADÁLYOZÁSÁNAK CÉLJÁBÓL. A FŰRÁS ELŐTT BIZONYOSODJON MEG ARRÓL, HOGY A FŰRÁS HELYÉN NEM TALÁLHATÓ GÁZ-, VÍZ- VAGY ELEKTROMOS VEZETÉK. EGYÉB FALAKRA TÖRTÉNŐ RÖGZÍTÉSHEZ SPECIÁLIS TIPLIK SZÜKSÉGESEK. AZ EGYES FALTÍPUSOKKAL HASZNÁLHATÓ MEGFELELŐ CSAVAROKKAL ÉS/VAGY TIPLIKKEL KAPCSOLATOS INFORMÁCIÓKÉRT KÉRJÜK, FORDULJON FORGALMAZÓJÁHOZ. A NEM SZAKSZERŰ SZERELÉSÉRT ÉS AZ ABBÓL KELETKEZŐ KÁROKÉRT A GYÁRTÓT SEMMILYEN FELELŐSSÉG NEM TERHELI. MINDEN CSAVART ELLENŐRIZZEN ÉS RÖGZÍTSEN RENDSZERESEN.

RO - INDICAȚIE DE AVERTIZARE:

DACĂ PRODUSUL ESTE LIVRAT ÎMPREUNĂ CU ȘURUBURI ȘI DIBLURI, ACESTEA SUNT DESTINATE EXCLUSIV UTILIZĂRII PE PEREȚII CONSTRUIȚI DIN MATERIALE MASIVE ȘI UNIFORME, PENTRU A PREVENI RĂSTURNAREA PRODUSULUI. ÎNAINTE DE A REALIZA GĂURILE, ASIGURAȚI-VĂ CĂ NU EXISTĂ CONDUCTE DE GAZ, APĂ SAU ELECTRICITATE ÎN LOCUL PE CARE DORIȚI SĂ-L GĂURIȚI. PENTRU PRINDEREA PE ALTE TIPURI DE PEREȚI, TREBUIE SĂ UTILIZAȚI DIBLURI SPECIALE. INTERESAȚI-VĂ LA MAGAZINUL SPECIALIZAT, PENTRU A GĂSI ȘURUBURILE ȘI/SAU DIBLURILE POTRIVITE PENTRU PERETELE DVS. PRODUCĂTORUL NU ESTE RESPONSABIL, ÎN CAZUL UNUI MONTAJ NECORESPUNZĂTOR PENTRU DAUNELE REZULTATE. VĂ RUGĂM SĂ VERIFICAȚI TOATE ȘURUBURILE LA INTERVALE REGULATE ȘI SĂ LE STRÂNGEȚI.

HR - UPOZORENJE:

AKO SU UZ PROIZVOD PRILožENE TIPLI I VIJCI, ONI SU NAMIJENJENI ISKLJUČIVO ZA KORIŠTENJE NA ZIDOVIMA OD ČVRSTIH I JEDNOLIČNIH MATERIJALA KAKO BI SE SPRIJEČILO PREVRTANJE. PRIJE BUŠENJA PROVJERITE DA NA MJESTU BUŠENJA NEMA ELEKTRIČNIH VODOVA, PLINSKIH ILI VODOVODNIH CIJEVI. ZA PRIČVRŠĆIVANJE NA OSTALE ZIDOVE POTREBNO JE KORISTITI POSEBNE TIPLI. PRILIKOM KUPNJE RASPITAJTE SE KOD SVOG PRODAVAČA O VIJCIMA I TIPLAMA KOJI SU PRIKADNI ZA ODGOVARAJUĆU ZIDNU STRUKTURU. PROIZVOĐAČ NE ODGOVARA ZA ŠTETE NASTALE USLIJED NEPRAVILNE MONTAŽE. SVE VIJKE POTREBNO JE REDOVITO PROVJERAVATI I ZATEGNUTI.

SI - OPOZORILO:

ČE SO BLAGU PRILožENI ZIDNI VLOŽKI IN VIJAKI, SO TI NAMENJENI IZKLJUČNO ZA UPORABO NA STENAH IZ MASIVNIH IN ENOTNIH MATERIALOV, DA SE PREPREČI PREVRNITEV. PRED VRTANJEM SE PREPRIČAJTE, DA NA MESTU VRTANJA NI PLINSKIH, VODNIH ALI ELEKTRIČNIH NAPELJAV. ZA PRITRDITEV NA DRUGE STENE JE TREBA UPORABLJATI POSEBNE ZIDNE VLOŽKE. POZANIMAJTE SE V TRGOVINI O VIJAKIH IN/ALI ZIDNIH VLOŽKIH, PRIMERNIH ZA POSAMEZNO SESTAVO STENE. PROIZVAJALEC NE PREVZEMA JAMSTVA ZA NEPRAVILNO MONTAŽO IN ZARADI TEGA NASTALO ŠKODO. VSE VIJAKE REDNO PREVERJAJTE IN NAKNADNO PRIVIJAJTE.